



Komar University of Science and Technology

PTE 3310C
Reservoir Rock Properties
LABORATORY MANUAL

December 2015

CONTENTS

1. Laboratory Safety.....	1
1.1. The principle of Safety	1
1.2. First Aid	2
1.3. Safety Rule	3
1.4. Chemical Transportation	3
1.5. Chemical Hazard	3
1.6. Chemical Disposal	4
2. Cleaning and saturation determination.....	5
2.1. Definitions	5
2.2. Measurement methods	5
2.2.1. Direct injection of solvent	5
2.2.2. Centrifuge flushing	6
2.2.3. Gas-driven solvent extraction	6
2.2.4. Soxhlet extraction	6
2.2.5. Dean-Stark distillation extraction	6
2.2.6. Vacuum distillation	7
2.2.7. Summary	8
2.3. Experiments	9
2.3.1. Saturation determination, Dean-Stark distillation method (Exp.1)	9
3. Porosity.....	11
3.1. Definitions	11
3.2. Effect of compaction on porosity	12
3.3. Porosity measurements on core plugs	12
3.3.1. Bulk volume measurement	13
3.3.2. Pore volume measurement	13
3.3.3. Grain volume measurement	15
3.4. Experiments	15
3.4.1. Effective porosity determination by helium porosimeter method (Exp. 2)	15
3.4.2. Porosity determination by liquid saturation method (Exp. 3)	17
4. Permeability.....	18
4.1. Definition	18
4.1.1. Darcy's law	18
4.1.2. Kozeny-Carman model	18
4.1.3. Klinkenberg Effect	20
4.1.4. Ideal gas law	21
4.1.5. High velocity flow	22
4.2. Measurement of permeability	23
4.2.1. Constant head permeameter	23

4.3	Experiments	25
4.3.1	Measurement of air permeability (Exp. 4)	25
4.3.2	Absolute permeability measurement of water (Exp. 5)	26
5.	Contact angle and wettability.....	28
5.1	Definitions	28
5.2	Measurement of wettability	30
5.2.1	Measurements on core samples	30
5.2.1.1	The Amott method	31
5.2.1.2	The centrifuge method	32
5.2.2	Contact angle measurements	34
5.2.2.1	The contact angle/imaging method	34
5.3	Experiments	35
5.3.1	Contact angle measurement using imaging method (Exp. 6)	35
6.	Capillary pressure.....	38
6.1	Definitions	38
6.2	Capillary pressure measurement methods	40
6.2.1	Porous plate method (restored state)	40
6.2.2	Centrifuge method	41
6.2.3	Mercury injection (Purcell method)	44
6.2.4	Dynamic method	45
6.2.5	Comparison of methods	46
6.3	Converting laboratory data	46
6.4	Experiments	47
6.2.1	Capillary pressure measurement using porous plate (Exp. 7)	47
6.2.2.	Capillary pressure measurement using centrifuge (Exp. 8)	49
7.	Resistivity.....	51
7.1	Definitions	51
7.2	Effect of conductive solids	53
7.3	Effect of overburden pressure on resistivity	55
7.4	Resistivity of partially water-saturated rocks	55
7.5	Experiments	56
7.5.1	Resistivity measurements of fluid-saturated rocks (Exp. 9)	56
	References	58

1 LABORATORY SAFETY

1 THE PRINCIPLES OF SAFETY

The main principles of safety in the lab to be considered are:

- 1 Safety Program
- 2 Be concerned about the safety of others
- 3 Understand the hazards associated with your particular experiment
- 4 Know what to do in an emergency
- 5 Report hazards or hazardous conditions

1.1.1. Safety Program

To achieve an effective safety program, some common basic rules must be established. Some of the more basic safety practices that you are expected for the student to follow are:

- Wear appropriate eye protection whenever working with any potential eye hazards.
- Use a hood for hazardous, volatile, and noxious chemicals.
- Label an experiment to show its in progress
- You are further expected to secure all gas cylinders, to label all containers, to observe posted signs, such as no smoking, and so on.

1.1.2. Be Concerned About the Safety of Others

Your concern for safety must include the people around you. Your experiment must be safely maintained so that everyone in the area is amply protected and warned of inherent dangers. Furthermore, it is expected for experimenter to alert lab occupants in case of an accident.

1.1.3. Understand the Hazards Associated with Your Particular Experiment

Prevention is the key to safety. Before designing any experiment, it is wise to consider the potential hazards and safety precautions involved in the work. Safety precautions should include correct materials storage, proper ventilation, proper grounding of equipment and training sessions when necessary. Material Safety Data Sheets (MSDS) and equipment manuals are important sources of information.

1.1.4. Know what to do in an Emergency

Student must be prepared to respond quickly and precisely to an emergency. You must familiarize yourself with the laboratory you are working in, its exits, and its associated safety equipment: eyewash stations, showers, sinks, fire blankets, fire extinguishers, and spill kits.

If there was an emergency such as a fire, gas leak, release of toxic fumes, or radiation leak, the following procedures should be followed:

- 1 Alert personnel in the immediate vicinity
- 2 Confine the fire or emergency, if possible
- 3 Summon aid
- 4 Evacuate the building to Mustered Point
- 5 Report to Safety Officer or Lab Manager.

1.2. **FIRST AID**

There are certain serious injuries in which time is so important that treatment must be started immediately.

1.2.1. **DIFFICULTIES OF BREATHING**

In case of difficulty of breathing (e.g. from electrical shock or asphyxiation), the mouth-to-mouth method of resuscitation is far superior to any other known. If victim is found unconscious on the floor and not breathing, rescue breathing must be started at once, seconds count.

1.2.2. **SEVERE BLEEDING**

Severe bleeding can almost always be controlled by firm and direct pressure on the wound with a pad or cloth. The cleaner the cloth, the more desirable it is; however, in an emergency, use part of the clothing.

1.2.3. **BURNS**

If the burn is minor, apply ice or cold water.

In case of deep burns:

- Distinguish the fire by a fire blanket
- Put the injured person under a safety shower, removing any clothing contaminated with chemicals.
- Keep the water running on the burn for several minutes to remove heat and wash area.
- Place clean, soaking wet, ice-packed cloth on burned areas.
- Never use a fire extinguisher on a person with burning clothing.

1.3. **SAFETY RULES**

1.3.1. **PERSONAL PRECAUTIONS:** The following precautions should be practiced during lab experiments:

- **Avoid working alone in the laboratory**
- **Use Eye protection**
- **Use ear protection during noisy experiment:**
- **Put proper mask when handling toxic chemicals**
- **Wear proper clothing gear and hand protection**
- **Keep personal hygiene and maintain the lab clean**

1.3.2. **LABORATORY PRACTICE**

- **HAZARDOUS CHEMICALS**

1. All containers must be labeled.
2. Do not use chemical from unlabeled containers.
3. Never taste or smell any chemical.
4. Clean spills immediately.

5. MERCURY SPILLS

For small spills or well contained spills, gather mercury and put it in a closed container (wear gloves). Use special filtered mercury vacuum for picking up larger spills. Never use a regular vacuum, the mercury will contaminate the vacuum a.

- **GLASSWARE**

1. Use only Pyrex or shutter proof glassware.
2. Never use cracked or chipped glassware.
3. Insert tubing properly into stoppers.

- **GAS CYLINDERS**

- Secure gas cylinders with a strap or chain to a stable object.
- Transport gas cylinders, with the cap security in place, and always use the proper cart.
- Before using gas in an experiment, be sure there are no leaks in the system.
- Never use grease or other lubricants on gauges or connections.
- Only use regulators, pipes and fitting specified for the type of gas you will be using.
- Do not locate gas cylinders near heat sources, like furnaces.
- Store oxygen cylinders and combustible gases separately

1.4. **CHEMICAL TRANSPORTATION**

When chemicals are carried by hand, they should be placed in a carrying container or acid-carrying bucket to protect against breakage and spillage. Chemicals should not be carried in open containers in hallways or elevators where they may be spilled.

1.4.1 **CHEMICAL STORAGE**

Every chemical should have a specific storage space. They should not be stored on counter tops where they can be knocked over or in hoods where they interfere with proper air flow. Flammable liquids should be stored in ventilated storage cabinets. Flammable liquids should not be stored near ignition sources or in areas where accidental contact with strong oxidizing agents is possible.

1.5. **CHEMICAL HAZARDS AND SAFETY PROCEDURES**

The first step in using any chemical should be a review of the material safety data sheet supplied by the manufacturer, available from the section's technician.

1.5.1. **ACIDS AND BASES**

Acids and bases are found in most laboratories since there are a variety of applications for them. Three important hazards are:

1. Chemical burns suffer from spills
2. Inhalation of caustic vapor
3. Fires or explosions caused by strongly exothermic reactions occurring when strong acid are diluted rapidly.

Strong bases may often cause more severe burns than acids. Therefore strong bases should be carefully handled.

1.5.2. **ORGANIC SOLVENTS**

Many organic solvents possess harmful vapors for human health. These organic solvents are also volatile and the vapors are flammable. One should be aware of the hazards,

and safety precautions while using these solvents.

Acetone: Possesses toxic and flammable vapors. Use proper ventilation, safety glasses and gloves

Methanol: Possesses harmful vapors that can cause dizziness, central nervous system depression and shortness of breath. So it should be used in a ventilated hood and neoprene gloves should be worn.

Benzene: Carcinogenic. Chronic poisoning can occur by inhalation of relatively small amounts over a long time. It can also be absorbed through the skin. Vapors are flammable and it should be stored carefully.

1.6. CHEMICAL WASTE DISPOSAL

Each individual has the responsibility for seeing that laboratory waste chemicals are safely collected, identified, stored for disposal, and that anyone involved is fully advised of the need for any special methods or facilities for proper disposal. Disposal of chemical waste down the drain to the sanitary sewer systems is hazardous. Material flushed to the sewer can be dangerous to maintenance personnel and the public. Chemical vapors and odors can re-circulate back into the buildings.

2. CLEANING AND SATURATION DETERMINATION

2.1 Definitions

Before measuring porosity and permeability, the core samples must be cleaned of residual fluids and thoroughly dried. The cleaning process may also be not used for fluid saturation determination.

Fluid saturation is defined as the ratio of the volume of fluid in a given core sample to the pore volume of the sample

$$S_w = \frac{V_w}{V_p} \quad S_o = \frac{V_o}{V_p} \quad S_g = \frac{V_g}{V_p} \quad (2.1)$$

$$S_w + S_o + S_g = 1 \quad (2.2)$$

where V_w , V_o , V_g and V_p are water, oil, gas and pore volumes respectively and S_w , S_o and S_g are water, oil and gas saturations. Note that fluid saturation may be reported either as a fraction of total porosity or as a fraction of effective porosity. Since fluid in pore spaces that are not interconnected can not be produced from a well, the saturations are more meaningful if expressed on the basis of effective porosity. The weight of water collected from the sample is calculated from the volume of water by the relationship

$$W_w = \rho_w V_w \quad (2.3)$$

where ρ_w is water density in g/cm^3 . The weight of oil removed from the core may be computed as the weight of liquid less weight of water

$$W_o = W_L - W_w \quad (2.4)$$

where W_L is the weight of liquids removed from the core sample in gram. Oil volume may then be calculated as W_o/ρ_o . Pore volume V_p is determined by a porosity measurement, and oil and water saturation may be calculated by Eq. (2.1). Gas saturation can be determined using Eq. (2.2)

2.2 Measurement Methods

2.2.1 Direct Injection of Solvent

The solvent is injected into the sample in a continuous process. The sample is held in a rubber sleeve thus forcing the flow to be uniaxial.

2.2.2 Centrifuge Flushing

A centrifuge which has been fitted with a special head sprays warm solvent onto the sample. The centrifugal force then moves the solvent through the sample. The used solvent can be collected and recycled.

2.2.3 Gas Driven Solvent Extraction

The sample is placed in a pressurized atmosphere of solvent containing dissolved gas. The solvent fills the pores of sample. When the pressure is decreased, the gas comes out of solution, expands, and drives fluids out of the rock pore space. This process can be repeated as many times as necessary.

2.2.4 Soxhlet Extraction

A Soxhlet extraction apparatus is the most common method for cleaning sample, and is routinely used by most laboratories. As shown in Figure 2.1a, toluene is brought to a slow boil in a Pyrex flask; its vapors move upwards and the core becomes engulfed in the toluene vapors (at approximately 110⁰C). Eventual water within the core sample in the thimble will be vaporized. The toluene and water vapors enter the inner chamber of the condenser, the cold water circulating about the inner chamber condenses both vapors to immiscible liquids. Recondensed toluene together with liquid water falls from the base of the condenser onto the core sample in the thimble; the toluene soaks the core sample and dissolves any oil with which it come into contact. When the liquid level within the Soxhlet tube reaches the top of the siphon tube arrangement, the liquids within the Soxhlet tube are automatically emptied by a siphon effect and flow into the boiling flask. The toluene is then ready to start another cycle.

A complete extraction may take several days to several weeks in the case of low API gravity crude or presence of heavy residual hydrocarbon deposit within the core. Low permeability rock may also require a long extraction time.

2.2.5 Dean-Stark Distillation-Extraction

The Dean-Stark distillation provides a direct determination of water content. The oil and water are extracted by dripping a solvent, usually toluene or a mixture of acetone and chloroform, over the plug samples. In this method, the water and solvent are vaporized, recondensed in a cooled tube in the top of the apparatus and the water is collected in a calibrated chamber (Figure 2.1b). The solvent overflows and drips back over the samples. The oil removed from the samples remains in solution in the solvent. Oil content is calculated by the difference between the weight of water recovered and the total weight loss after extraction and drying.

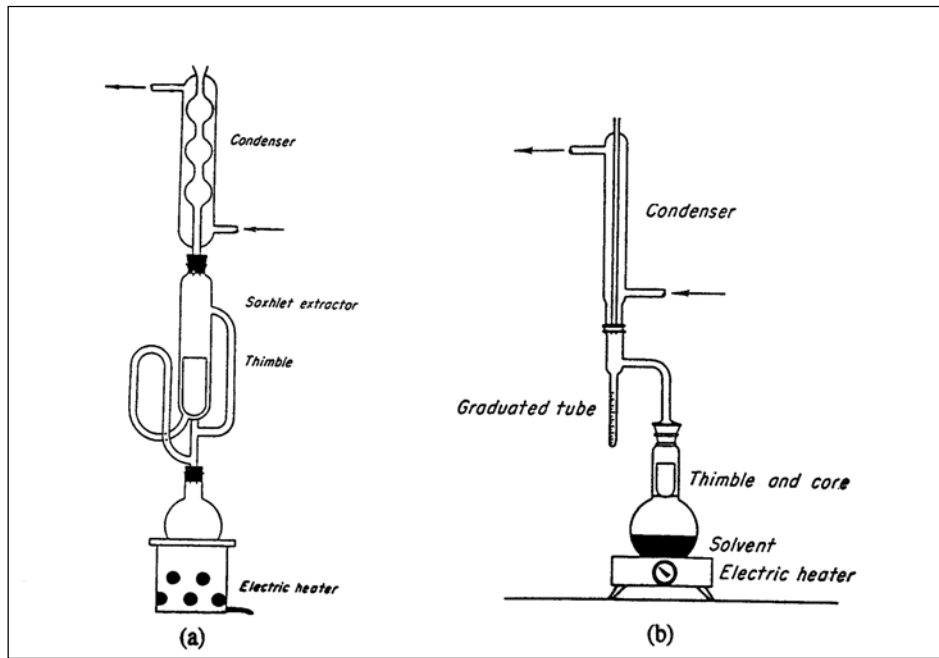

Fig. 2.1: Schematic diagram of Soxhlet (a) and Dean- Stark (b) apparatus.

2.2.6 Vacuum Distillation

The oil and water content of cores may be determined by this method. As shown in Figure 2.2, a sample is placed within a leakproof vacuum system and heated to a maximum temperature of 230°C. Liquids within the sample are vaporized and passed through a condensing column that is cooled by liquid nitrogen.

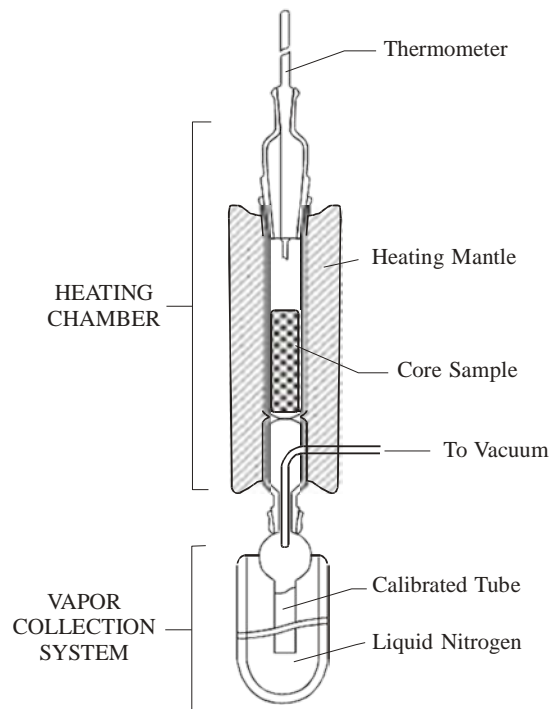

Fig. 2.2: Vacuum distillation Apparatus.

2.2.7 Summary

The direct-injection method is effective, but slow. The method of flushing by using centrifuge is limited to plug-sized samples. The samples also must have sufficient mechanical strength to withstand the stress imposed by centrifuging. However, the procedure is fast. The gas driven-extraction method is slow. The disadvantage here is that it is not suitable for poorly consolidated samples or chalky limestones. The distillation in a Soxhlet apparatus is slow, but is gentle on the samples. The procedure is simple and very accurate water content determination can be made. Vacuum distillation is often used for full diameter cores because the process is relatively rapid. Vacuum distillation is also frequently used for poorly consolidated cores since the process does not damage the sample. The oil and water values are measured directly and dependently of each other.

In each of these methods, the number of cycles or amount of solvent which must be used depends on the nature of the hydrocarbons being removed and the solvent used. Often, more than one solvent must be used to clean a sample. The solvents selected must not react with the minerals in the core. The commonly used solvents are:

- Acetone
- Benzene
- Benzen-methol Alcohol
- Carbon-tetrachloride
- Chloroform
- Methylene Dichloride
- Mexane
- Naphtha
- Tetra Chloroethylene
- Toluene
- Trichloro Ethylene
- Xylene

Toluene and benzene are most frequently used to remove oil and methanol and water is used to remove salt from interstitial or filtrate water. The cleaning procedures used are specifically important in special core analysis tests, as the cleaning itself may change wettabilities.

The core sample is dried for the purpose of removing connate water from the pores, or to remove solvents used in cleaning the cores. When hydratable minerals are present, the drying procedure is critical since interstitial water must be removed without mineral alteration. Drying is commonly performed in a regular oven or a vacuum oven at temperatures between 50⁰C to 105⁰C. If problems with clay are expected, drying the samples at 60⁰C and 40 % relative humidity will not damage the samples.

2.3 Experiments

2.3.1 Saturation Determination, Dean-Stark Distillation Method (Experiment 1)

Description:

The objective of the experiment is to determine the oil, water and gas saturation of a core sample.

Procedure:

1. Weigh a clean, dry thimble. Use tongs to handle the thimble.
2. Place the cylindrical core plug inside the thimble, and then quickly weigh the thimble and sample.
3. Fill the extraction flask two-thirds full with toluene. Place the thimble with sample into the long neck flask.
4. Tighten the ground joint fittings, but do not apply any lubricant for creating tighter joints. Start circulating cold water in the condenser.
5. Turn on the heating jacket or plate and adjust the rate of boiling so that the reflux from the condenser is a few drops of solvent per second. The water circulation rate should be adjusted so that excessive cooling does not prevent the condenser solvent from reaching the core sample.
6. Continue the extraction until the solvent is clear. Change solvent if necessary.
7. Read the volume of collected water in the graduated tube. Turn off the heater and cooling water and place the sample into the oven (from 105⁰C to 120⁰C), until the sample weight does not change. The dried sample should be stored in a desiccater.
8. Obtain the weight of the thimble and the dry core.
9. Calculate the loss in weight W_L , of the core sample due to the removal of oil and water.
10. Measure the density of a separate sample of the oil.
11. Calculate the oil, water and gas saturations after the pore volume V_p of the sample is determined.

Data and calculations:

Sample No:

Porosity, ϕ :

W_{org} g	W_{dry} g	ρ_w g/cm ³	ρ_o g/cm ³	V_w cm ³	W_o g	V_o cm ³	V_p cm ³	S_o	S_w	S_g

Where

 W_{org} : Weight of original saturated sample W_{dry} : Weight of desaturated and dry sample**Equations:**

$$W_L = W_{org} - W_{dry}$$

$$W_o = W_L - W_w$$

$$V_b = \pi (D/2)^2 L$$

$$V_p = \phi V_b$$

where D and L are diameter and length of the core sample, respectively.

3. POROSITY

3.1 Definitions

From the viewpoint of petroleum engineers, the two most important properties of a reservoir rock are porosity and permeability. Porosity is a measure of storage capacity of a reservoir. It is defined as the ratio of the pore volume to bulk volume, and is may be expressed as either a percent or a fraction. In equation form

$$\phi = \frac{\text{pore volume}}{\text{bulk volume}} = \frac{\text{bulk volume} - \text{grain volume}}{\text{bulk volume}}$$

Two types of porosity may be measured: total or absolute porosity and effective porosity. *Total porosity* is the ratio of all the pore spaces in a rock to the bulk volume of the rock. *Effective porosity* ϕ_e is the ratio of interconnected void spaces to the bulk volume. Thus, only the effective porosity contains fluids that can be produced from wells. For granular materials such as sandstone, the effective porosity may approach the total porosity, however, for shales and for highly cemented or vugular rocks such as some limestones, large variations may exist between effective and total porosity.

Porosity may be classified according to its origin as either primary or secondary. *Primary or original porosity* is developed during deposition of the sediment. Secondary porosity is caused by some geologic process subsequent to formation of the deposit. These changes in the original pore spaces may be created by ground stresses, water movement, or various types of geological activities after the original sediments were deposited. Fracturing or formation of solution cavities often will increase the original porosity of the rock.

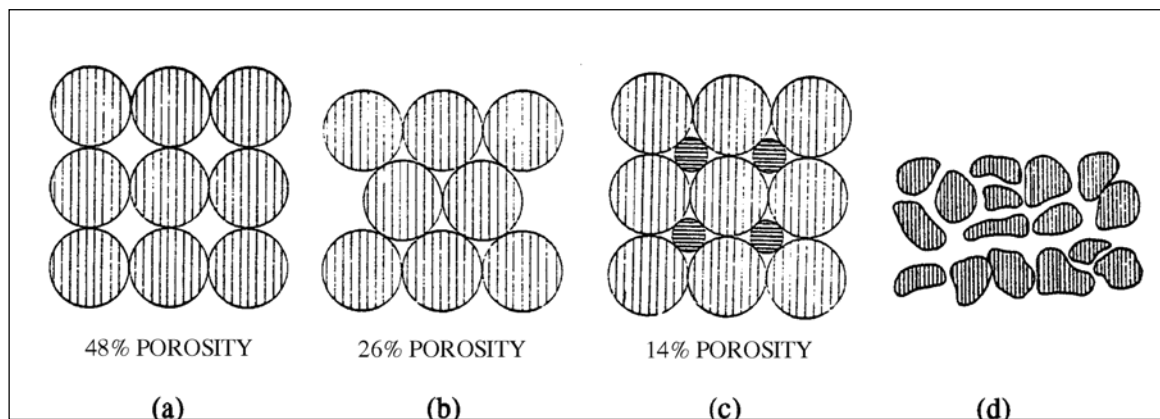

Fig. 3.1: Cubic packing (a), rhombohedral (b), cubic packing with two grain sizes (c), and typical sand with irregular grain shape (d).

For a uniform rock grain size, porosity is independent of the size of the grains. A maximum theoretical porosity of 48% is achieved with cubic packing of spherical grains, as shown in Fig. 3.1a. Rhombohedral packing, which is more representative of reservoir conditions, is shown in Fig. 3.1b; the porosity for this packing is 26%. If a second,

smaller size of spherical grains is introduced into cubic packing (Fig. 3.1c), the porosity decreases from 48% to 14%. Thus, porosity is dependent on the grain size distribution and the arrangement of the grains, as well as the amount of cementing materials. Not all grains are spherical, and grain shape also influences porosity. Atypical reservoir sand is illustrated in Fig. 3.1d.

3.2 *Effect of Compaction on Porosity*

Compaction is the process of volume reduction due to an externally applied pressure. For extreme compaction pressures, all materials show some irreversible change in porosity. This is due to distortion and crushing of the grain or matrix elements of the materials, and in some cases, recrystallization. The variation of porosity with change in pressure can be represented by

$$\phi_2 = \phi_1 e^{c_f(P_2 - P_1)} \quad (3.1)$$

where ϕ_2 and ϕ_1 are porosities at pressure P_2 and P_1 respectively, and c_f is formation compressibility. Formation compressibility is defined as summation of both grain and pore compressibility. For most petroleum reservoirs, grain compressibility is considered to be negligible. Formation compressibility can be expressed as

$$c_f = \frac{1}{V} \frac{dV}{dP} \quad (3.2)$$

where dP is change in reservoir pressure. For porous rocks, the compressibility depends explicitly on porosity.

3.3 *Porosity Measurements on core plugs*

From the definition of porosity, it is evident that the porosity of a sample of porous material can be determined by measuring any two of the three quantities: Bulk volume, pore volume or grain volume. The porosity of reservoir rock may be determined by

- Core analysis
- Well logging technique
- Well testing

The question of which source of porosity data is most reliable cannot be answered without reference to a specific interpretation problem. These techniques can all give correct porosity values under favourable conditions. The core analysis porosity determination has the advantage that no assumption needs to be made as to mineral composition, borehole effects, etc. However, since the volume of the core is less than the rock volume which is investigated by a logging device, porosity values derived from logs are frequently more accurate in heterogeneous reservoirs.

In the following sections we will discuss how to estimate pore-, grain-, and bulk-volumes from core plugs.

3.3.1 Bulk Volume Measurement

Although the bulk volume may be computed from measurements of the dimensions of a uniformly shaped sample, the usual procedure utilises the observation of the volume of fluid displaced by the sample. The fluid displaced by a sample can be observed either *volumetrically* or *gravimetrically*. In either procedure it is necessary to prevent the fluid penetration into the pore space of the rock. This can be accomplished (1) by coating the sample with paraffin or a similar substance, (2) by saturating the core with the fluid into which it is to be immersed, or (3) by using mercury.

Gravimetric determinations of bulk volume can be accomplished by observing the loss in weight of the sample when immersed in a fluid or by change in weight of a pycnometer with and without the core sample.

3.3.2 Pore Volume Measurement

All the methods measuring pore volume yield effective porosity. The methods are based on either the extraction of a fluid from the rock or the introduction of a fluid into the pore spaces of the rock.

One of the most used methods is the helium technique, which employs Boyle's law. The helium gas in the reference cell isothermally expands into a sample cell. After expansion, the resultant equilibrium pressure is measured. The Helium porosimeter apparatus is shown schematically in Fig. 3.2.

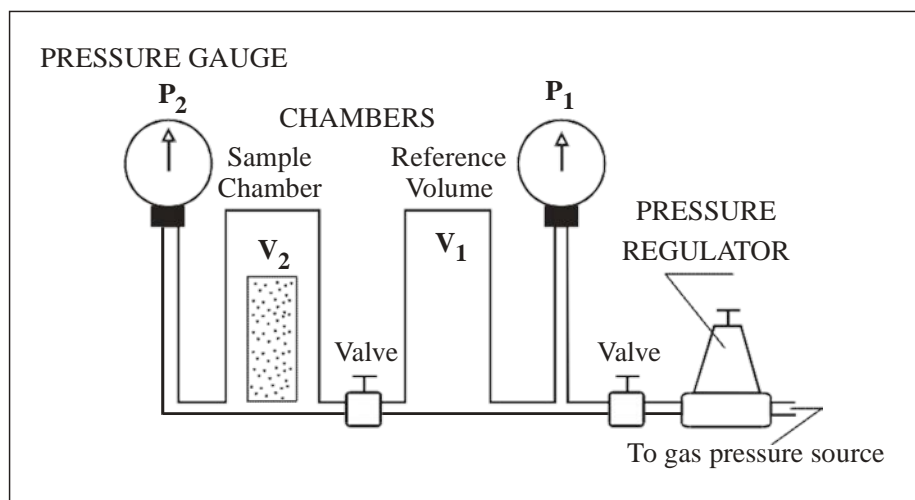

Fig. 3.2: Schematic diagram of helium porosimeter apparatus.

Helium has advantages over other gases because: (1) its small molecules rapidly penetrated small pores, (2) it is inert and does not adsorb on rock surfaces as air may do, (3) helium can be considered as an ideal gas (i.e., $z = 1.0$) for pressures and temperatures usually employed in the test, and (4) helium has a high diffusivity and therefore affords a useful means for determining porosity of low permeability rocks.

The schematic diagram of the helium porosimeter shown in Fig. 3.2 has a reference volume V_1 , at pressure p_1 , and a matrix cup with unknown volume V_2 , and initial pressure p_2 . The reference cell and the matrix cup are connected by tubing; the system can be brought to equilibrium when the core holder valve is opened, allowing determination of the unknown volume V_2 by measuring the resultant equilibrium pressure p . (Pressure p_1 and p_2 are controlled by the operator; usually $p_1 = 100$ and $p_2 = 0$ psig). When the core holder valve is opened, the volume of the system will be the equilibrium volume V , which is the sum of the volumes V_1 and V_2 . Boyle's law is applicable if the expansion takes place isothermally. Thus the pressure-volume products are equal before and after opening the core holder valve:

$$p_1V_1 + p_2V_2 = p(V_1 + V_2) \quad (3.3)$$

Solving the equation for the unknown volume, V_2 :

$$V_2 = \frac{(p - p_1)V_1}{p_2 - p} \quad (3.4)$$

Since all pressures in equation (3.4) must be absolute and it is customary to set $p_1 = 100$ psig and $p_2 = 0$ psig, Eq. (3.4) may be simplified as follows:

$$V_2 = \frac{V_1(100 - p)}{p} \quad (3.5)$$

where V_2 in cm^3 is the unknown volume in the matrix cup, and V_1 in cm^3 is the known volume of the reference cell. p in psig is pressure read directly from the gauge.

Small volume changes occur in the system, including the changes in tubing and fittings caused by pressure changes during equalization. A correction factor, G , may be introduced to correct for the composite system expansion. The correction factor G is determined for porosimeters before they leave the manufacturer, and this correction is built into the gauge calibration in such a way that it is possible to read the volumes directly from the gauge.

Another method of pore volume determination is to saturate the sample with a liquid of known density, and noting the weight increase (gravimetric method).

When a rock has a small fraction of void space, it is difficult to measure porosity by the mentioned methods. At this case, mercury injection is used. The principle consists of forcing mercury under relatively high pressure in the rock pores. A pressure gauge is attached to the cylinder for reading pressure under which measuring fluid is forced into the pores. Fig. 5.3b shows a typical curve from the mercury injection method. The volume of mercury entering the core sample is obtained from the device with accuracy up to 0.01 cm^3 .

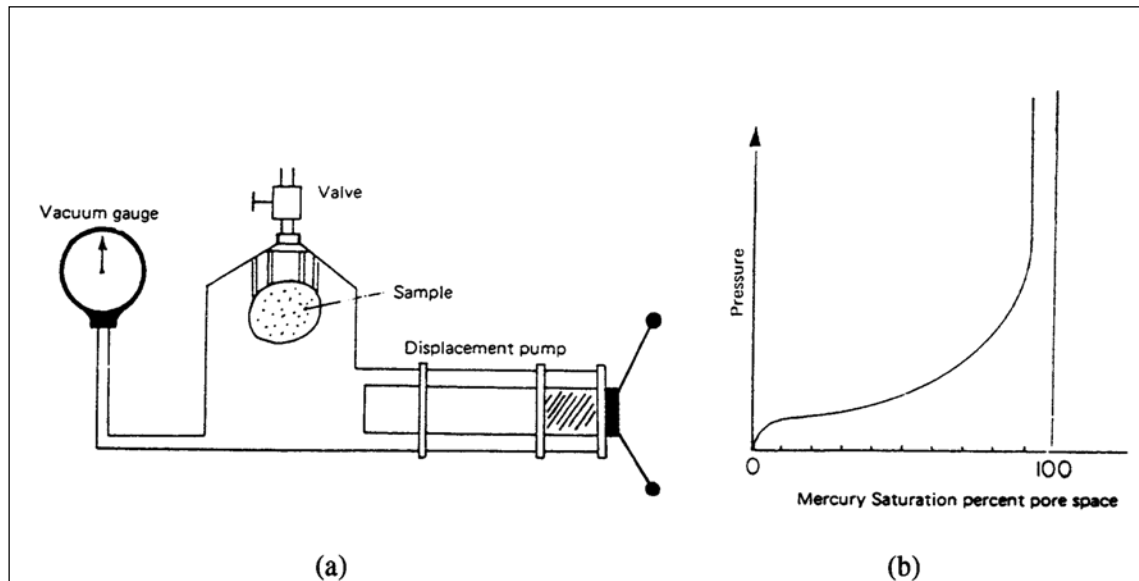

Fig. 3.3: Mercury injection pump (a) and porosity through mercury injection (b).

3.3.3 Grain Volume Measurement

The grain volume of pore samples is sometimes calculated from sample weight and knowledge of average density. Formations of varying lithology and, hence, grain density limit applicability of this method. Boyle's law is often employed with helium as the gas to determine grain volume. The technique is fairly rapid, and is valid on clean and dry sample.

The measurement of the grain volume of a core sample may also be based on the loss in weight of a saturated sample plunged in a liquid.

Grain volume may be measured by crushing a dry and clean core sample. The volume of crushed sample is then determined by (either pycnometer or) immersing in a suitable liquid.

3.4 Experiments

3.4.1 Effective Porosity Determination by Helium Porosimeter Method (Experiment 2)

Descriptions

The helium porosimeter uses the principle of gas expansion, as described by Boyle's law. A known volume (reference cell volume) of helium gas, at a predetermined pressure, is isothermally expanded into a sample chamber. After expansion, the resultant equilibrium pressure is measured. This pressure depends on the volume of the sample chamber minus the rock grain volume, and then the porosity can be calculated.

Procedure:

1. Measure the diameter and length of the core using calliper.
2. Give the porosimeter a helium supply, 10 bar.
3. Determine the volume of the matrix cup with core, V_2 :
 - 3.1 Put the cleaned, dried core inside the matrix cup, and mount the cup in the cup holder.
 - 3.2 Open “source” and then “supply”.
 - 3.3 Regulate the needle at 100.
 - 3.4 Close “source” and then “supply”.
 - 3.5 Open “core holder”.
 - 3.6 Take the reading on TOP SCALE, $V_2 = \text{cm}^3$.
4. Determine the volume of the matrix cup without core, V_1 :
 - 4.1 Take out the core from the matrix cup, and mount the cup in the cup holder.
 - 4.2 Open “source” and then “supply”.
 - 4.3 Open “cell 1”.
 - 4.4 Regulate the needle at 100.
 - 4.5 Close “source and then “supply”.
 - 4.6 Open core “holder”.
 - 4.7 Take the reading on MIDDLE SCALE, $V_1 = \text{cm}^3$.

Calculations and report

1. Calculate and fill the data form.

Core No.: D : cm, L : cm.

V_1 (cm ³)	V_2 (cm ³)	V_g (cm ³)	V_b (cm ³)	Φ_e

where

- V_1 = the volume of the matrix cup without core, cm^3 .
- V_2 = the volume of the matrix cup with core, cm^3 .
- $V_g = V_1 - V_2$, the volume of grain and non-connected pores, cm^3 .
- V_b = the bulk volume of core, cm^3 .
- $\Phi_e = (V_b - V_g) / V_b$ effective (interconnected) porosity of the core, *fraction*.

3.4.2 Porosity Determination by Liquid Saturating Method (Experiment 3)

Description:

The determination of the effective liquid porosity of a porous plug is the initial part of the measurement of capillary pressure using porous plate method in core laboratories. Before the capillary pressure is determined the volume of the saturating liquid (brine or oil) in the core must be known. Thus, the effective liquid porosity of the core can be calculated in the beginning of capillary pressure measurement.

Procedure:

1. Weigh dry Berea plug W_{dry} , measure its diameter D , and length L , with calliper (1 core for each group).
2. Put the cores in the beaker inside a vacuum container, run vacuum pump about 1 hour.
3. Saturate the cores with 36 g/l NaCl brine, $\rho_{brine} = 1.02\text{g/cm}^3$.
4. Weigh the saturated cores, W_{sat} .

Calculations and report:

1. Calculate the saturated brine weight, $W_{brine} = W_{sat} - W_{dry}$.
2. Calculate the pore volume (saturated brine volume), $V_p = W_{sat} / \rho_{brine}$.
3. Calculate effective porosity, $\phi_e = V_p / V_b$.

Core No.:	D : cm,	L : cm.		
W_{dry} (g)	W_{sat} (g)	W_{brine} (g)	V_p (cm ³)	ϕ_e

4. PERMEABILITY

4.1 Definition

Permeability is a property of the porous medium and it is a measure of capacity of the medium to transmit fluids. Permeability is a tensor that in general is a function of pressure. Usually, the pressure dependence is neglected in reservoir calculations, but the variation with position can be pronounced. Very often the permeability varies by several magnitudes, and such heterogeneity will of course influence any oil recovery.

4.1.1 Darcy's Law

Darcy (1856) performed a series of experiments on the relationship affecting the downward flow of water through sands. The generalised equation called Darcy's law may be written in the form

$$\bar{u} = - \frac{\bar{k}}{\mu} (\nabla P + \rho \bar{g}) \quad (4.1)$$

where \bar{u} is superficial velocity, \bar{k} is permeability tensor, μ is fluid viscosity, ∇P is pressure gradient, ρ is fluid density and \bar{g} is gravitational vector. Writing flow velocity v as the ratio of volumetric rate to cross-sectional area perpendicular to flow q/A in distance L , Darcy's law can be expressed

$$\frac{q}{A} = v = \frac{k \Delta P}{\mu L} \quad (4.2)$$

The dimensions of permeability can be established by substituting the units of the other in the equation. The unit darcy results from the choice of c_{gs} system units

$$\text{darcy}[D] = \frac{q[cm^3/s] \mu[cp] L[cm]}{\Delta P[atm] A[cm^2]}$$

The permeability in SI system has dimension of m^2 .

4.1.2 Kozeny-Carman Model

Formation permeability may be determined or estimated on the basis of core analysis, well tests, production data, well log interpretations, or correlations based on rock permeabilities. One of these often used pore models is Kozeny-Carman Model.

The volumetric flow rate q in a horizontal capillary of radius R and length L_t is given by Hagen-Poiseuille's equation

$$q = \frac{\pi R^4 \Delta P}{8\mu L_t} \quad (4.3)$$

and the average velocity in the tube is

$$\bar{v} = \frac{q}{\pi R^2} = \frac{R^2 \Delta P}{8\mu L_t} \quad (4.4)$$

We have to transform this equation to the scale of a representative element volume (REV). The REV is defined as a volume below which local fluctuations in permeability is large. If we make the travel time in the capillary tube equal to that in a REV, then

$$\left(\frac{L_t}{A v_t}\right) = \left(\frac{L}{A v_{REV}}\right) \quad (4.5)$$

The relation between interstitial and superficial velocity is $v = u/\phi$. Darcy's law can be used to eliminate v and we obtain the permeability component k

$$k = \frac{R^2 \phi}{8\tau} \quad (4.6)$$

where $\tau = (L_t/L)^2$ is the tortuosity. This is an important media property and is usually estimated from electrical resistivity measurements. The tortuosity is in the range of 2 to 5 for most reservoir rocks.

The capillary radius R in Eq. (4.6) is difficult to define for a porous medium, but may be approximated by the hydraulic radius R_h that expresses the ratio between volume open to flow and the wetted surface area. For a porous and permeable medium we have:

$$R_h = \frac{\pi R^2 L}{2\pi R L} = \frac{R}{2} \xrightarrow{10.6} k = \frac{R_h^2 \phi}{2.7} \quad (4.7)$$

$$R_h = \frac{\phi}{a(1-\phi)} \quad (4.8)$$

where a is internal surface area per volume, an important intrinsic property of permeable media. By substituting these expressions for R_h in Eq. (4.6) and solving the equation for an assemblage of uniform spheres where $a = 6/D$ we get the Kozeny-Carman equation

$$k = \frac{1}{72\tau} \frac{\phi^3 D^2}{(1-\phi)^2} \quad (4.9)$$

where D is sphere or particle diameter, and we see that permeability is a strong function of particle size and packing through ϕ . The Kozeny-Carman equation is often used to make order-of-magnitude estimates of pore size from knowledge of permeability. However, the capillary tube model is of limited value since it does not provide alternate

pathways for fluid flow within each REV. The consequence is that we cannot predict relative permeabilities or trapped phase saturations, parameters of major importance in oil recovery processes.

4.1.3 Klinkenberg Effect

Klinkenberg has reported variations in permeability determined by using gases as the flowing fluid compared to those obtained when using non-reactive liquids. These variations were considered to be due to slippage, a phenomenon well known with respect to gas flow in capillary tubes. The phenomenon of gas slippage occurs when the diameter of the capillary openings approach the mean free path of the gas. The mean free path of a gas is a function of molecular size and the kinetic energy of the gas. Therefore, permeability of gas depends on factors which influence the mean free path, such as temperature, pressure and the molecular size of the gas.

Fig. 4.1 is a plot of the permeability of a porous medium as determined at various mean pressures using three different gases. Note that for each gas a straight line is obtained for the observed permeability as a function of the reciprocal of the mean pressure of the test. All the lines when extrapolated to infinite mean pressure ($1/P_m = 0$) intercept the permeability axis at a common point. This point is designated k_L , or the equivalent liquid permeability.

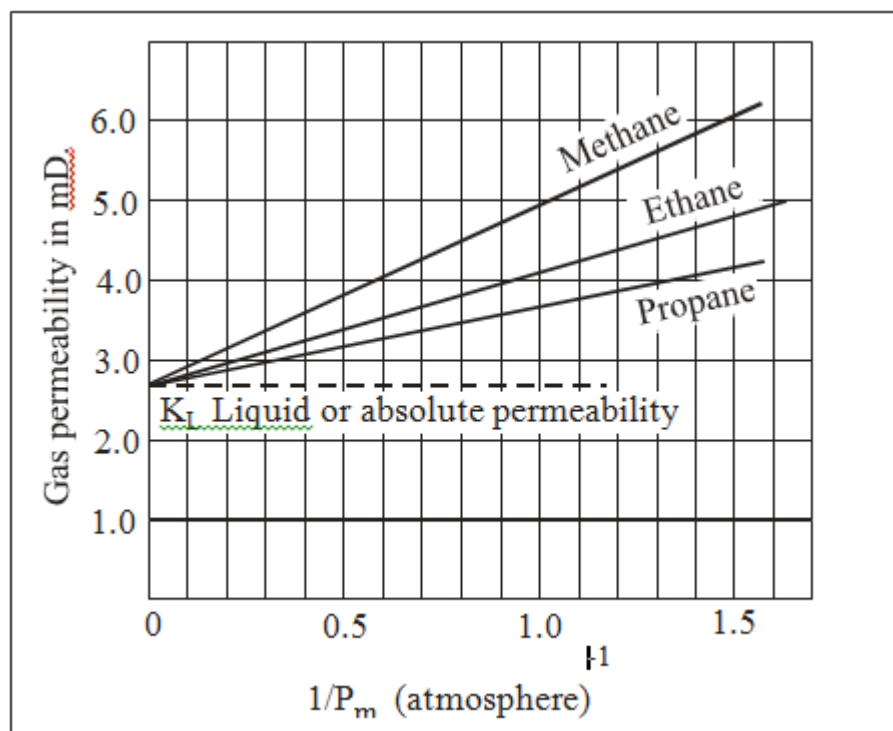

Fig. 4.1: Variation in gas permeability with mean pressure and type of gas.

Klinkenberg has related apparent permeability k_a measured for gas for an average pressure P_m to the true permeability k_L by

$$k_a = k_L \left(1 + \frac{b}{P_m} \right) \quad (4.10)$$

where b is constant depending upon the average free movement λ of the molecule at P_m

$$b = \frac{4C'\lambda P_m}{r} \quad (4.11)$$

where r is channel radius and $C' \approx 1$.

4.1.4 Ideal Gas Flow

Darcy's equation defining permeability is linked to laminar flow in porous media. This laminar flow is not always achieved especially in gas flows. Let us suppose that there is a metal tube filled with sand (Fig. 4.2). Upstream and downstream pressure P_1 and P_2 are constants.

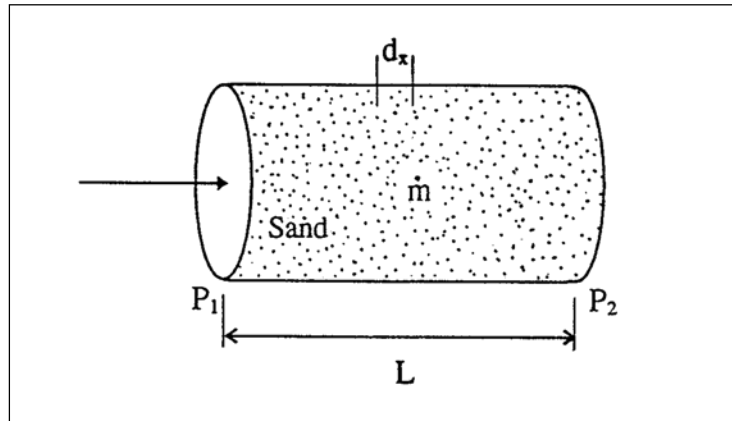

Fig 4.2: Linear flow of an ideal gas in sand-filled tube.

The mass flow m is the same in all slices and each slice is related to the volume flow rate Q by

$$m = Q \cdot \rho \quad (4.12)$$

where ρ is gas density in the slice when pressure is P . Using Boyle's law, relationship $\rho = bP$ can be applied where b is a constant. And then

$$Q = \frac{1}{bP} m \quad (4.13)$$

By substituting Q in Darcy's equation, a differential relation between P and distance x may be obtained

$$bPdP = \frac{\mu m}{A k} dx \quad (4.14)$$

After integration for distance L

$$\frac{b}{2} (P_1^2 - P_2^2) = \frac{\mu m}{A k} L \quad (4.15)$$

and taking into account that $m = QbP$, we get

$$Q_{atm} = \frac{Ak}{\mu L} \frac{(P_1^2 - P_2^2)}{2P_{atm}} \quad (4.15)$$

The gas flow is measured at atmospheric conditions, thus $P_{atm} = 1$ atm.

4.1.5 High Velocity Flow

For high flow rates, Darcy's law is not valid. The range of flow rate which laminar flow exists is dependent on the Reynolds number which is a dimensionless quantity. The Reynolds number for porous media is defined as

$$R^* = \frac{d v \rho}{\mu} \quad (4.17)$$

where v is average velocity (q/A), ρ is fluid density, μ is fluid viscosity and d is the average sand grain diameter. For example, in sand, transition from laminar to turbulent flow occurs in the range of Reynolds number from 1 to 10.

Many models were suggested to replace or modify Darcy's law for high-velocity flow. The most accepted model for non-Darcy flow was proposed by Forchheimer in 1901

$$-\nabla P = a v + b v^2 \quad (4.18)$$

where a and b are constants and $v = q/A$. Later work resulted in an equation in terms of fluid and rock properties

$$-\nabla P = \frac{\mu}{k} v + \beta \rho v^2 \quad (4.19)$$

where β is high velocity coefficient and μ , ρ are viscosity and density of the gas respectively. The high velocity coefficient is a property of the formation rock that accounts for the deviation from Darcy's law which is more pronounced in gas flow than in oil flow. There are several correlations for β exist in the literature. Usually, β is taken as a property of the reservoir rock which may be estimate from

$$\beta = \frac{\text{const.}}{k^\alpha} \quad (4.20)$$

where α is constant which can be determined experimentally from a known permeable formation.

4.2 Measurement of Permeability

Permeability is measured by passing a fluid of known viscosity through a core sample of measured dimensions and then measuring flow rate and pressure drop. Various techniques are used for permeability measurements of cores, depending on sample dimensions and shape, degree of consolidation, type of fluid used, ranges of confining and fluid pressure applied, and range of permeability of the core. Two types of instruments are usually used in the laboratory:

- (a) Variable head permeameter, IFP type.
- (b) Constant head permeameter, Core Laboratories type.

Permeability tests are performed on samples which have been cleaned and dried and a gas (usually air) is used for flowing fluid in the test. This is because:

1. steady state is obtained rapidly,
2. dry air will not alter the minerals in the rock, and
3. 100% fluid saturation is easily obtained.

Measured values using constant head equipment range from a low of 0.1 mD to 20 D. Data accuracy declines at high and low permeability values and is within $\pm 0.5\%$ of true value otherwise.

4.2.1 Constant Head Permeameter

This equipment is designed for plug or whole core permeability measurements. This experiment may be used for single or multiphase, compressible fluid or liquid measurements and can also be used under reservoir pressure and temperature.

Fig 3.3 shows a diagram of a constant head permeameter. Air is usually used as gas flow. Upstream and downstream pressures are measured by manometers on both sides of the core and air flow is measured by means of a calibrated outlet. Air permeability can then be calculated using Eq. (4.16).

Hassler core holder may be used with this instrument. The Hassler system is an improvement of the rubber plug system whose tightness is limited at certain pressures. The core is placed in a flexible rubber tube (Fig. 4.4). The Hassler cell has these advantages:

- Excellent tightness.
- Can be used for samples of different sizes.

- Much higher pressure or ΔP can be used.
- Can be used for measuring relative permeability.

Darcy's equation may be used for determining permeability of liquids. The volumetric flow rate q is constant for liquids, because the density does not change during flow through the core.

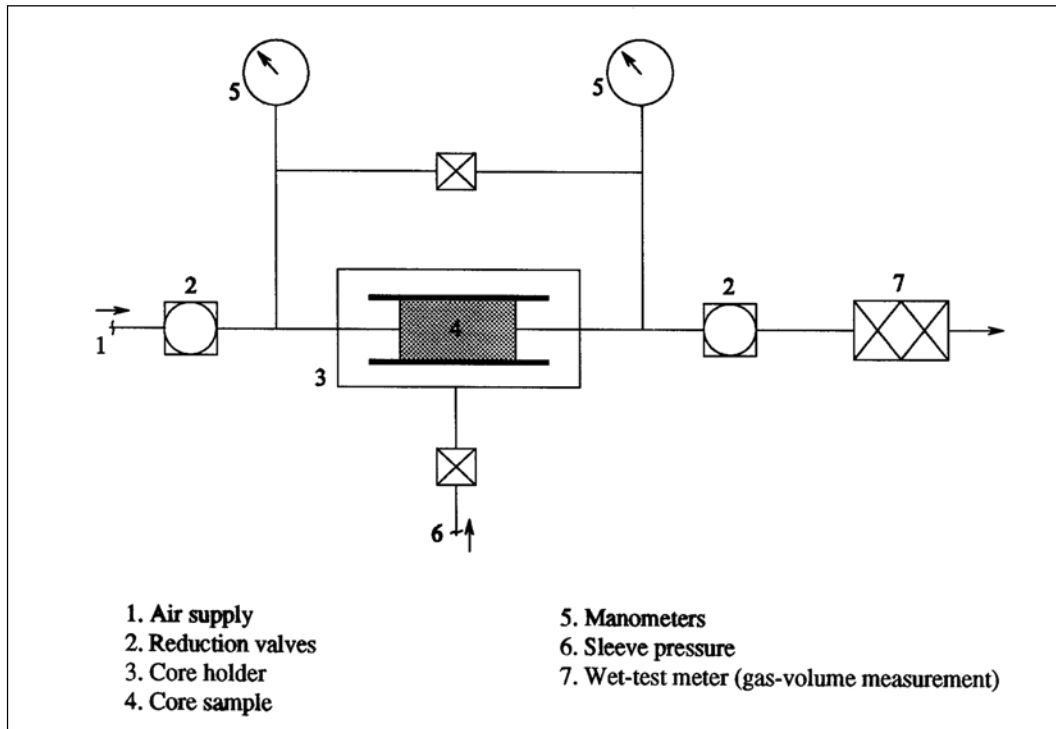

Fig. 4.3: Schematic diagram of permeameter.

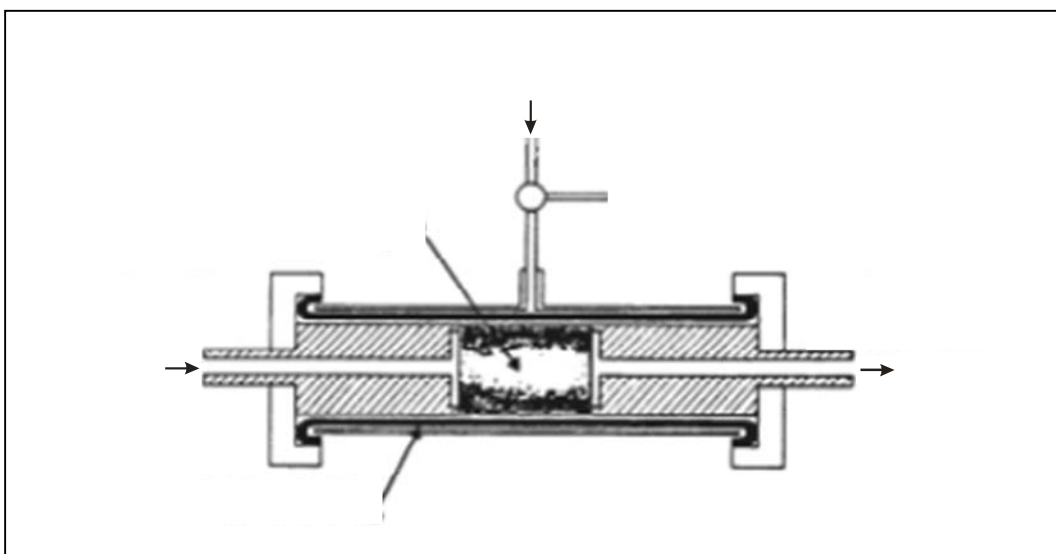

Fig.4.4: Hassler type core holder.

4.3 Experiments

4.3.1 Measurement of Air Permeability (Experiment 4)

Description:

The constant head permeameter with the Hassler cell is used to measure the air permeability.

Procedure:

The measured air permeability is influenced by the mean pressure P_m of the core. The mean pressure is regulated by the upstream and downstream values on the sides of Hassler cell. The rate is measured at atmospheric conditions with a mass flow meter in percent of maximum rate which is 200 l/hour. Air viscosity as a function of temperature is shown in Fig. 4.5.

Four measurements of air permeability will be taken at different pressures. It is important to keep the ΔP constant, because the air flow at the core sample must be laminar. It is best to have relative little pressure difference, ΔP . To avoid turbulent flow, use a maximal $\Delta P = 0.2$ bar.

Results and Calculation:

1. Calculate air permeability from Eq. (4.16).
2. Plot k versus $1/P_m$ and calculate k_L .
3. Calculate Klinkenberg constant b .

Inlet pressure P_1	Outlet pressure P_2	$1/P_m$	Rate in %	Q_{1atm}

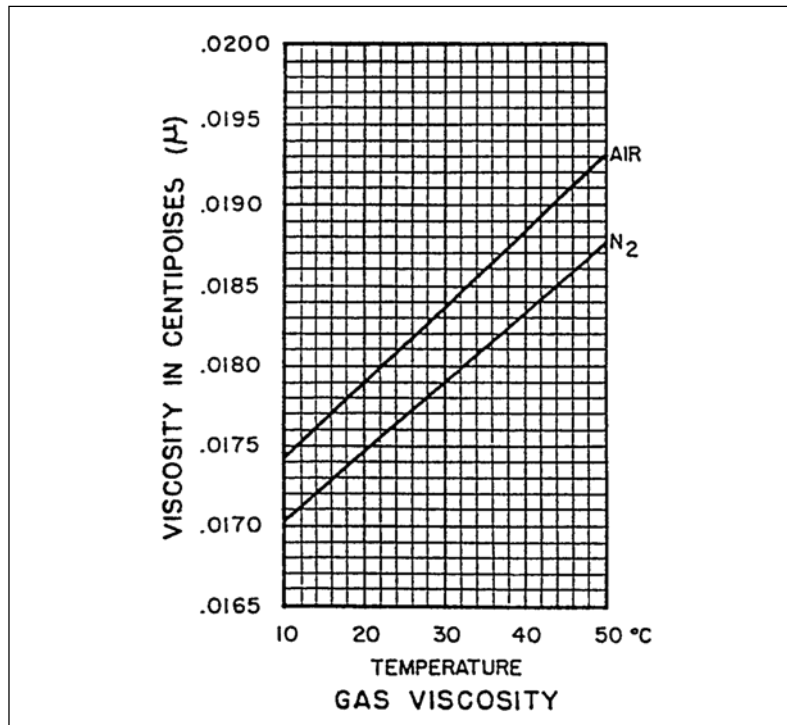

Fig. 4.5: Gas viscosity as a function of temperature.

Thin section

You will see two different thin section in microscope. What sample has lowest or highest permeability? Use the number of sample as reference. Give reasons for your answer.

Number of sample with lowest permeability	Number of sample with highest permeability

4.3.2 Absolute Permeability Measurement of Water (Experiment 5)

Description:

The objective of this experiment is to measure the absolute permeability of water using a method based on the Darcy theory.

Procedure:

1. Weight a dry Berea plug W_{dry} , measure its diameter D and length L , with caliper. Saturate the core with 36 g/l NaCl brine and weigh the plug, W_{sat} .

2. Mount the core in core holder.
3. Measure three flow rates under three driving pressures: 0.6, 0.8, 1.0, or 1.2 bar. Each measurement collects water production V_w , in $\Delta T = 60$ seconds.
4. Plot a line through the three ΔP - V_w data in a grid paper. Calculate the absolute permeability k_{abs} and absolute injectivity I_{abs} .

Calculations and report:

Core No.:	D : cm,	L : cm,	W_{dry} : g,	W_{sat} : g.	
$\Delta T_{(i)}$ = 60"	$\Delta P_{(1)}$ bar	$\Delta P_{(2)}$ bar	$\Delta P_{(3)}$ bar	k_{abs} darcy	I_{abs} cm/s.bar
V_w					

Liquid data:

$$\rho_w = 1.020 \text{ g/cm}^3, \quad \mu_w = 1.04 \text{ cp}$$

$$I_{abs} = \text{Absolute (water) injectivity} = V_w / (\Delta T \cdot A \cdot \Delta P)$$

where V_w is volume of water produced in time ΔT .

Calculation of k_{abs} :

$$k_{abs} = (\mu_w L V_w) / (A \Delta T \Delta P)$$

$$(\mu_w L) / (k \cdot A \cdot \Delta T) = \text{slope of the } \Delta P\text{-}V_w \text{ plot}$$

$$A = \text{Section area of the core, cm}^2.$$

5. CONTACT ANGLE AND WETTABILITY

5.1 Definitions

When a liquid is brought into contact with a solid surface, the liquid either expand over the whole surface or form small drops on the surface. In the first case the liquid will wet the solid completely, whereas in the later case a contact angle $\theta > 0$ will develop between the surface and the drop.

When two immiscible fluids contact a solid surface, one of them tends to spread or adhere to it more so than the other. For example, for water-oil-solid system at equilibrium, the following equation (known as Young's equation) can be expressed

$$\sigma_{so} - \sigma_{sw} = \sigma_{wo} \cos\theta \quad (5.1)$$

where σ_{so} is the interfacial tension between the oil and solid, σ_{sw} between the water and solid, σ_{wo} between the oil and water. θ is the contact angle measured through the water phase (Fig. 5.1).

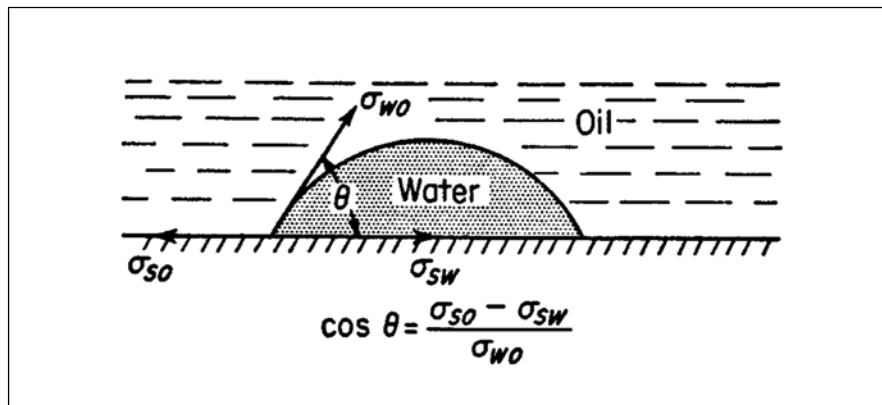

Fig. 5.1: Interfacial tensions for water-oil-solid system at equilibrium.

Adhesion tension, which is a function of the interfacial tension, determines which fluid preferentially wets the solid. In the case of water-oil-solid, the adhesion tension A_T is defined as

$$A_T = \sigma_{so} - \sigma_{sw} = \sigma_{wo} \cos\theta \quad (5.2)$$

A positive adhesion tension A_T indicates that water preferentially wets the solid surface (water wet). An A_T of zero indicates that both phases have an equal affinity for the surface (neutral system). A negative A_T indicates the oil wets the solid surface (oil wet). The magnitude of the adhesion tension determines the ability of the wetting phase to adhere to the solid and to spread over the surface of the solid.

Wettability of a reservoir rock-fluid system is defined as the ability of one fluid in the presence of another to spread on the surface of the rock. Wettability play an important role in the production of oil and gas as it not only determines initial fluid distributions, but also is a main factor in the flow processes in the reservoir rock. The degree of wetting of solid by liquids is usually measured by the contact angle that a liquid-liquid interface makes with a solid.

Based on the contact angle, the *wetting index* *WI* is defined according to the tabulation below:

Wetting Index $\cos\theta$	Contact angle θ	Wetting condition
1.0	0^0	completely water wetted
0	90^0	neutral system
-1.0	180^0	completely oil wetted

The limits of the scales are not definite, since a system with contact angle in the range of about 70^0 to 110^0 is considered neutral. Another scaling system is used during Experiment 9.

Another definition related to wetting is *spreading wetting*. In spreading wetting the adhesion forces between the liquid and the solid are greater than the cohesive forces between the liquid molecules, and the liquid will spread on the surface as a thin film. The spreading coefficient *S* is defined by the expression

$$S = -\frac{dG}{dA} = \sigma_{so} - (\sigma_{sw} + \sigma_{ow}) \quad (5.3)$$

where *dG* is the free energy increase due to spreading and *dA* is change in interfacial area. The liquid spreads spontaneously over the solid surface when *S* is positive or zero. When *S* is negative the liquid remains as a drop having a definite angle of contact with the solid surface. The equilibrium contact angle is such that the total surface free energy of the system is minimum.

To illustrate that, the quantitative relation between interfacial tension, contact angle and spreading coefficient are tabulated below:

Relative values	θ	S
$\sigma_{so} < \sigma_{sw}$	$90^0 < \theta < 180^0$	$S < 0$
$\sigma_{so} = \sigma_{sw}$	$\theta = 90^0$	$S < 0$
$\sigma_{sw} < \sigma_{so} < \sigma_{sw} + \sigma_{ow}$	$0^0 < \theta < 90^0$	$S < 0$
$\sigma_{so} = \sigma_{sw} + \sigma_{ow}$	$\theta = 0^0$	$S = 0$
$\sigma_{so} > \sigma_{sw} + \sigma_{ow}$	θ does not exist	$S > 0$

The wettability of a reservoir rock system will depend on the following factors

- Reservoir rock material and pore geometry
- Geological mechanisms (accumulation and migration)
- Composition and amount of oil and brine
- Physical conditions; pressure and temperature
- Mechanisms occurring during production; i.e. change in saturations, pressure and composition.

Note that it is difficult to make a general model of wettability including all these factors. Although a lot of work has been done on wettability, it is not fully understood how the wettability of a porous rock surface is composed.

5.2 *Measurement of Wettability*

No satisfactory method exists for in situ measurement of wettability, and therefore it is necessary to estimate the wettability from laboratory measurements.

To obtain representative information on wetting preferences in the reservoir from laboratory experiments, the following conditions should be fulfilled:

- The method should not damage the surface properties of the rock.
- The method should enable differentiation of entire range of wettability from very water-wet to very oil-wet.
- The results should include the effects of microheterogeneities of the rock (except where ideal systems are used).
- The results should not depend on parameters such as rock permeability and fluid viscosity unless these parameters can be isolated.
- The results should be reproducible both with respect to a given core sample and also between different cores having the same rock properties.

One way in which this can be done directly is by using the method of contact angle measurement by photographing a drop. Other indirectly methods are based on measurement on core samples. Three methods have been found worth discussing in more detail. These methods are:

- The Amott method
- The centrifuge method
- The contact angle method.

5.2.1 Measurements on Core Samples

In porous media the contact angle is determined indirectly. The methods are mainly based on measurements during displacement tests. But the problem is that no valid theory is developed for the relationship between displacement pressure and wetting preference.

The most common methods for measuring wettability on core samples are

- Displacement test with two different fluids
- Capillary pressure measurements
- Measurements of nuclear magnetic relaxation rate
- Measurement of dye absorption
- Imbibition measurements
- Imbibition and displacement (Amott method).

The test developed by Amott seems to be most accepted and widely used test in the oil industry.

5.2.1.1 The Amott Method

In principle, a core sample is chosen and saturated with oil. The oil-saturated sample is then placed in an imbibition cell surrounded by water. The water is allowed to imbibe into the core sample displacing oil out of the sample until equilibrium is reached (Fig. 5.2a). The volume of water imbibed is measured.

The core sample is then removed and the remaining oil in the sample is forced down to residual saturation by displacement with water. This may be done either in a centrifuge or displaced with a pump in a sealed core holder. The volume of oil displaced may be measured directly or determined by weight measurements.

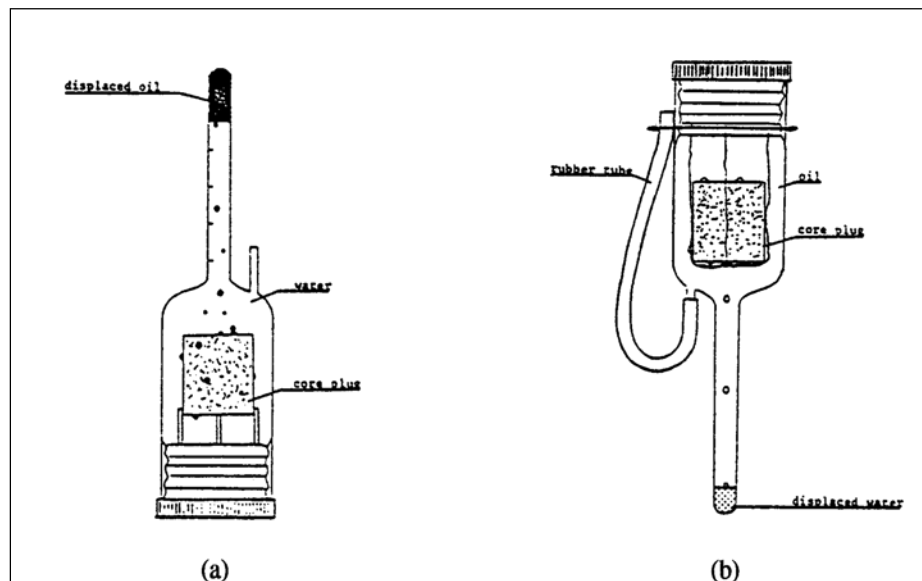

Fig. 5.2: Imbibition cell with oil saturated core plug surrounded by water (a) and water saturated core plug surrounded by oil (b).

The core, now saturated with water at residual oil saturation, is placed in an imbibition cell and surrounded by oil. The oil is allowed to imbibe into the core displacing water out of the sample (Fig. 5.2b). The volume of water displaced is measured (equal to volume of oil imbibed). The core is removed from the cell after equilibrium is reached, and

remaining water in the core is forced out by displacement in a centrifuge. The volume of water displaced is measured.

By recording all volumes produced, it is possible to calculate a wettability-index WI

$$WI = \frac{V_{O1}}{V_{O1} + V_{O2}} - \frac{V_{W1}}{V_{W1} - V_{W2}} = r_w - r_o \quad (5.4)$$

where V_{O1} = volume of oil produced during water imbibition
 V_{O2} = volume of oil produced during water flooding
 V_{W1} = volume of water produced during oil “imbibition”
 V_{W2} = volume of water produced during oil flooding
 r_w = displacement-with-water-ratio
 r_o = displacement-with-oil-ratio.

The wettability index will be a number between –1.0 and 1.0 where

$WI = 1.0$ completely water wetting
 $WI = 0.0$ neutral
 $WI = -1.0$ completely oil wetting.

The test is a fully empirical test but is based on some theoretical reasoning. A drawback is that the tests are difficult to perform at reservoir pressure and temperature.

5.2.1.2 The Centrifuge Method

The centrifuge method for determining wettability is based on a correlation between the degree of wetting and the areas under the capillary pressure curves. The method employs the two areas under the oil-water capillary pressure curves obtained from the centrifuge method (Fig. 5.3).

The examples in Fig. 5.3 show capillary-pressures for a water wet, oil wet and neutral system. The procedure to obtain a set of curves is as follows:

1. A core sample is saturated with brine.
2. The core is then placed in a centrifuge core holder.
3. The core holder is filled with oil and rotated at a certain speeds to obtain curve I (primary drainage) in Fig. 5.3.
4. The core is placed in an inverted core holder filled with brine. The brine is allowed to spontaneously imbibe into the core. Then the core is centrifuged at incremental steps (curve II of Fig. 5.3 - forced imbibition).
5. The core is placed in a core holder filled with oil and curve III (secondary drainage) is obtained in the centrifuge.
6. The areas under the two curves (II and III) are determined.

The method is often called the USBM-method (USBM is abbreviation for United States Bureau of Mines).

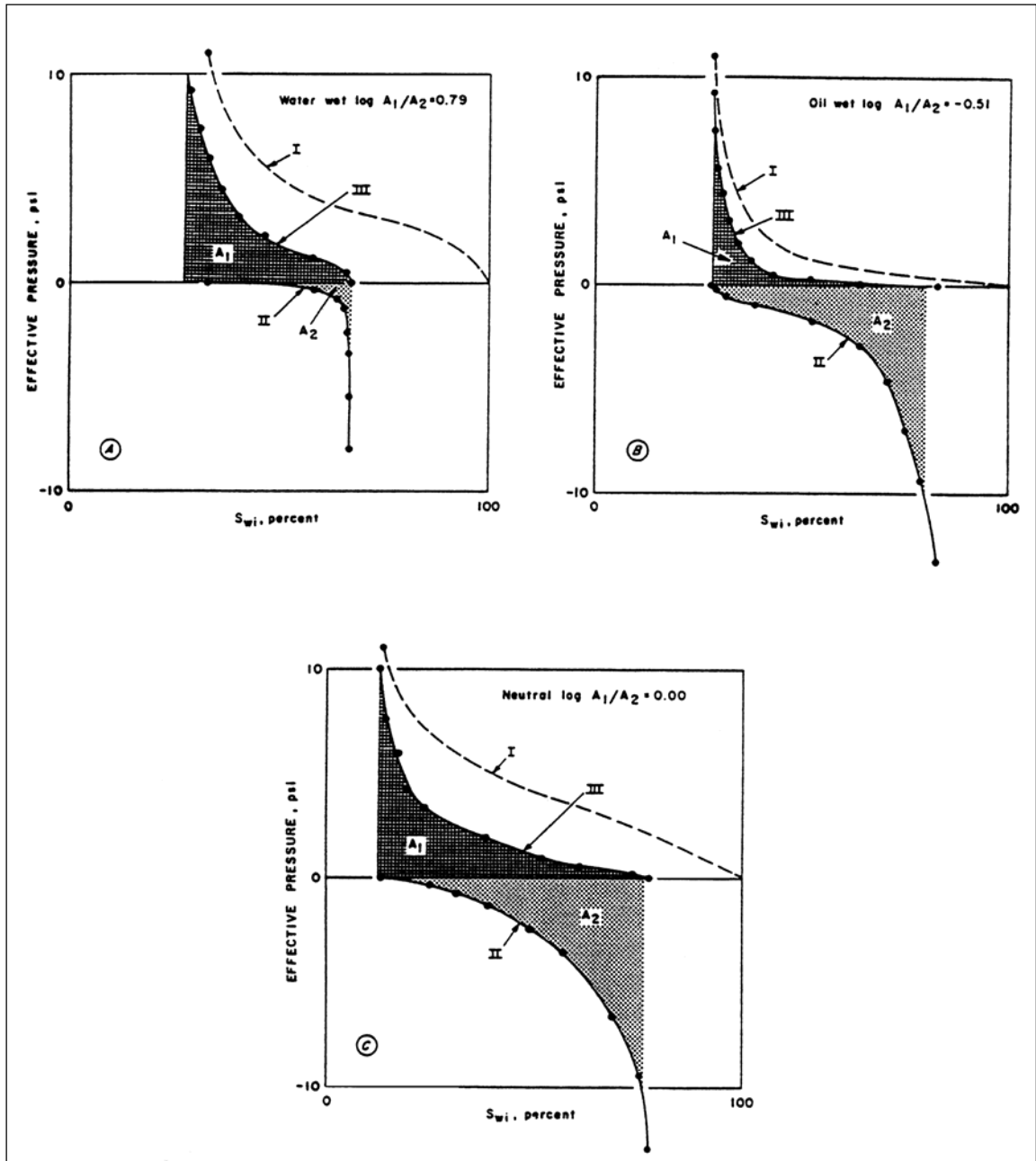

Fig. 5.3: Effect of wettability on the area ratio of capillary-pressure curves: (A) water wet, (B) oil wet and (C) neutral system.

We select the logarithm of the area ratio to define the wettability scale; $WI_{USBM} = \log(A_1/A_2)$. The relative wetting tendencies of the liquids in a porous medium and the distribution of pore sizes determine the shape of the capillary-pressure curves. In general, water-wet systems should have a larger area in the water-displaced-by-oil curves (area A_1 of Fig. 5.3A) than the area under the oil-displaced-by-water curves (area A_2 of Fig. 5.3A). Therefore, the logarithm of the area ratio for the water-wet system is greater than zero. Conversely, the area ratio is less than unity for oil-wet systems (Fig. 5.3B) and the logarithm of the ratio is negative. Fig. 5.3C shows a case where the ratio is close to 1.0.

The method has been tested against the Amott-test, and the two tests gave generally consistent results. The centrifuge test, however, seemed to differentiate better in the near-neutral area.

The centrifuge method is rapid, employs native fluids, and the test was found to be independent of oil viscosity. The method is better physically and mathematically grounded than the Amott-test. As for the Amott method, the method is difficult to perform at elevated pressures (reservoir conditions).

5.2.2 Contact Angle Measurements

There exist a variety of methods for measuring contact angle such as tilting plate method, Wilhelmy gravitational method and capillary rise method. The commonly used method is to measure contact angle directly for a drop of liquid resting on a plane surface of the solid, the so-called imaging method.

5.2.2.1 The Contact Angle/Imaging Method

The measurement of contact angles is based on Young's equation. When placing a drop of liquid on a solid surface, a finite angle of contact will in most cases be observed. However, complete spreading may also occur and then Young's equation ceases to hold.

The measurement of contact angle is simple in concept, but in practice it is a very complex topic and the interpretation of results is not straightforward. The measurement puts up severe demands to the cleaning procedures and the preparation of fluids and solid surface. The contact angle between oil, water and a solid surface will depend on the following:

- crude oil composition
- surface electric properties (pH and salt content of water)
- the solid surface itself
- roughness and heterogeneity of the solid surface
- dynamic effects
- pressure and temperature

In practice, in a porous material it is even more complex because of different pore shapes and complex mineralogy.

The solid surface must be carefully polished, and measurements on mineral surfaces are often performed on the natural plane of cleavage. A drop of liquid is placed on the solid surface and an enlarged image of the drop is obtained by photographing. The dimensions of the drop image are measured and used to determine the contact angle.

Contaminations will affect the contact angle, so the cleaning procedures are critical. Most contact angle measurements are performed at room conditions, and this is often due to the time consuming cleaning procedures necessary for measurement at high pressure and temperature and complex and costly apparatus needed.

Contact angle measurements can also be performed at reservoir conditions, which is one of the main advantages in crude oil-brine-rock system, as it has been shown that especially temperature may change the wettability significantly.

5.3 Experiments

5.3.1 Contact Angle Measurement using Imaging Method (Experiment 6)

Contact angle measurement is a classical method widely used in chemical engineering to derive the wettability in three-phase system (gas/liquid/solid, or liquid/liquid/solid). The method was introduced into petroleum engineering more than 50 years ago. This method is used to determine reservoir formation wettability. The *imaging method* is easily carried out in the laboratory and gives you a clear understanding of wetting mechanism in oil-water-rock system.

Generally, sandstone formation and carbonate formation are represented by small polished quartz and carbonate blocks, respectively. A small drop (2-3 mm³) of water is laid on the smooth surface of rock which has previously been submerged in an oil-filled transparent cell. Then, the enlarged image of the water drop is obtained by photographing. The dimensions of the drop image are used to calculate the contact angle in the system.

Definition:

Fig. 5.1 shows two liquids, oil and water, in contact with a solid. In petroleum engineering the contact angle, θ , is measured through the denser liquid phase (water), and ranges from 0 to 180°. In a three phase system, where the three interfacial forces are in thermodynamic equilibrium:

$$\sigma_{so} - (\sigma_{sw} + \sigma_{wo} \cos\theta_{wo}) = 0 \quad (5.1)$$

and then,

$$\theta_{wo} = \cos^{-1} \left(\frac{\sigma_{so} - \sigma_{sw}}{\sigma_{wo}} \right) \quad (5.5)$$

Because the measurements of solid/liquid interfacial tensions (σ_{so} , σ_{sw}) are impractical in the core laboratory, Eq. (5.5) is useless to calculate contact angle θ . Generally, the *image method* is used to obtain the picture of the contact angle or pendant drop. Fig. 5.4 is the set-up of an image system applied in our laboratory.

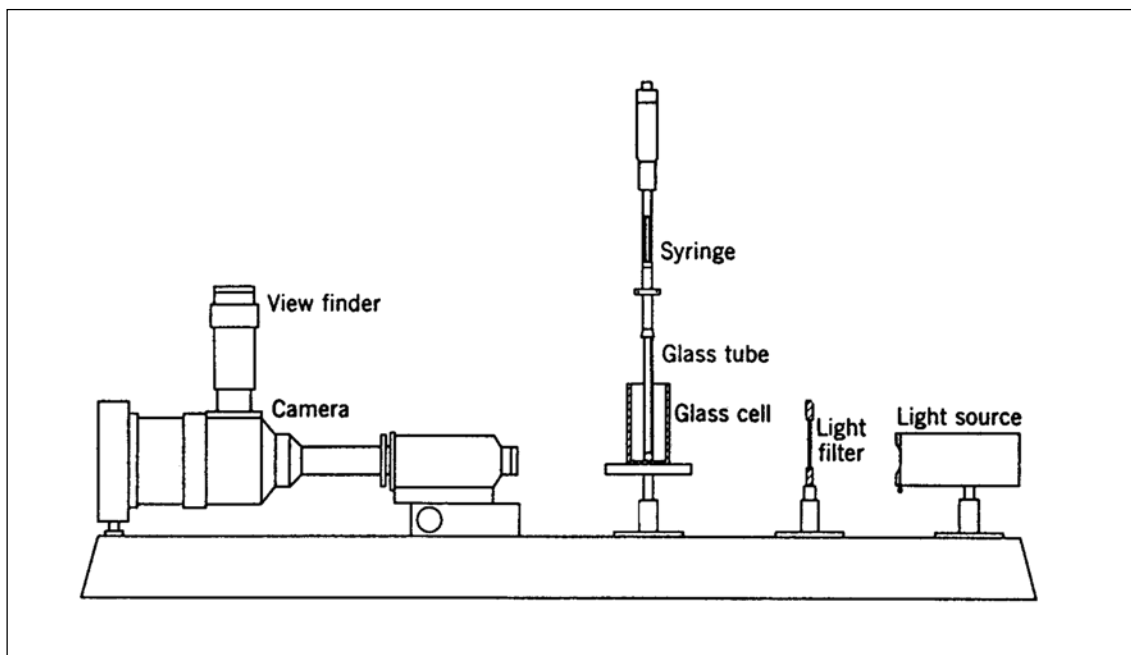

Fig. 5.4: The image system set-up.

Procedure:

1. Fill the cell with oil phase and then put a polished quartz or carbonate cube into the cell
2. Carefully inject several water drops onto the cube surface with a medical syringe.
3. Adjust the imaging system until a drop is in focus (a clear outline of the image appears on the screen).
4. Take image picture and measure the dimension of the drop image.

Calculations and report:

Temperature: $^{\circ}\text{C}$

system	dimension, mm		contact angle, degree	system wettability
	H	D		

Equation:

$$\theta = 2 \tan^{-1} \left(\frac{2H}{D} \right)$$

$\theta < 62^\circ$ -----water-wet, $\theta = 62^\circ$ - 133° -----intermediate-wet, $\theta > 133^\circ$ -----oil-wet

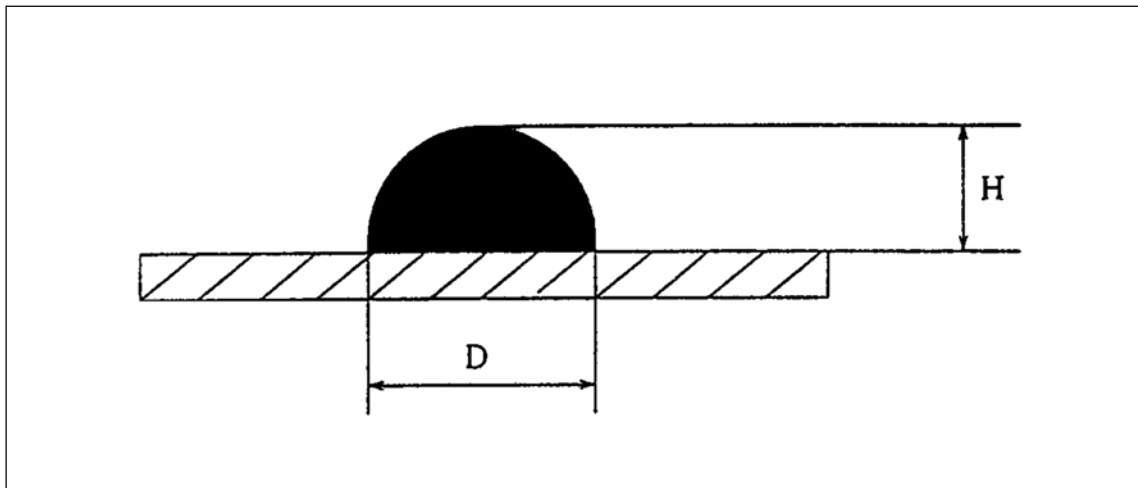

6. CAPILLARY PRESSURE

6.1 Definitions

When two immiscible fluids are in contact in the interstices of a porous medium, a discontinuity in pressure exists across the interface separating them. The difference in pressure P_c is called capillary pressure, which is pressure in the non-wetting phase minus the pressure in the wetting phase

$$P_c = P_{non-wetting} - P_{wetting} \quad (6.1)$$

Thus, the capillary pressure may have either positive or negative values. For an oil-water, gas-water or gas-oil system, capillary pressure is defined as

$$P_c = P_o - P_w \quad (6.2)$$

$$P_c = P_g - P_w \quad (6.3)$$

$$P_c = P_g - P_o \quad (6.4)$$

The hydrostatic pressure of a liquid with density ρ is dependent on the elevation z as follows

$$\frac{dP}{dz} = \rho g \quad (5.5)$$

For an oil-water system, the capillary pressure becomes

$$\frac{dP_c}{dz} = (\rho_w - \rho_o)g \quad (6.6)$$

If fluid columns are continuous in the reservoir, the following relationship holds

$$P_c(z) = P_c(z_0) + g \int_{z_0}^z (\rho_w - \rho_o) dz \quad (6.7)$$

where $P_c(z)$ is capillary pressure at height z above z_0 and ρ_w , ρ_o are densities of water and oil, respectively.

The capillary pressure is a result of the curvature of fluid interfaces, according to the well-known Laplace equation

$$P_c = \sigma \left(\frac{1}{r_1} + \frac{1}{r_2} \right) \quad (6.8)$$

where σ is interfacial tension between the two fluids and r_1 and r_2 are principle radii of curvature.

The condition for capillary forces to exist is a certain curvature of the fluid-fluid interface. The relation between fluid saturation and capillary pressure in the reservoir is a function of pore sizes, wettability, interfacial tension and fluid saturation history (drainage and imbibition). Based on laboratory measurements of capillary pressure, it is possible to convert those into reservoir capillary pressure. From these values fluid saturations in the reservoir can be evaluated.

An example of the capillary pressure versus saturation relationship (capillary pressure function) is shown in Fig. 5.1. It is apparent that the relationship between capillary pressure and saturation is not unique, but depends on the saturation history of the system. Definitions of the main terms are as follows (oil-water system):

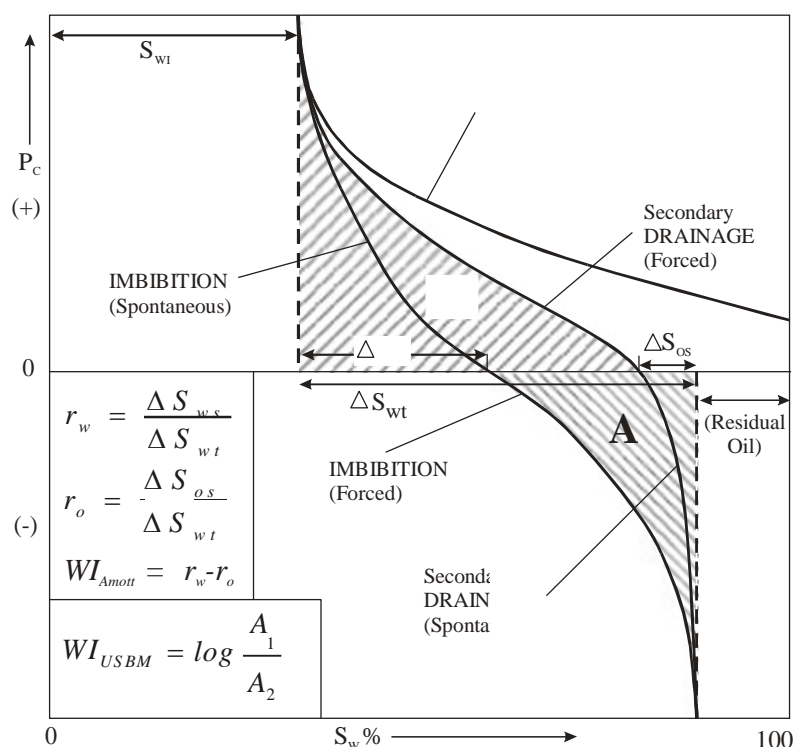

Fig. 6.1: Typical capillary pressure curves and the relationships of wettability measurements by Amott and USBM tests to P_c .

Irreducible water saturation S_{wi} : The reduced volume of the wetting phase retained at the highest capillary pressure where wetting phase saturation appears to be independent of further increases in the externally measured capillary pressure.

Residual oil saturation S_{or} : The reduced volume of the non-wetting phase which is entrapped when externally measured capillary pressure is decreased from a high value to a big negative value.

Primary drainage curve: The relationship characteristic of the displacement of the wetting phase from 100% saturation to the irreducible saturation.

Imbibition curve: The relationship characteristic of the displacement of the non-wetting phase from the irreducible saturation to the residual saturation.

Secondary drainage curve: The relationship characteristic of the displacement of the wetting phase from residual saturation to the irreducible saturation.

Most experimental evidences indicate that the irreducible saturation obtained by primary drainage is the same as that obtained by secondary drainage. When the residual saturation is the same, the imbibition after secondary drainage will follow exactly the imbibition curve obtained after primary drainage. Thus, the secondary drainage curve and the imbibition curve constitute a closed and reproducible hysteresis loop.

The capillary pressure hysteresis as can be seen in Fig. 9.1 is a result of the different mechanisms governing filling/ emptying of pores with a non-wetting or a wetting fluid respectively. Contact angle hysteresis is one factor also contributing to hysteresis.

6.2 Capillary Pressure Measurement Methods

6.2.1 Porous Plate Method (restored state)

Water saturated samples for air-water or oil-water tests and oil saturated cores for air-oil tests are placed on a semi-permeable diaphragm, and a portion of the contained liquid is displaced with the appropriate fluid of air or oil. A schematic diagram of an apparatus for performing such tests is seen in Fig. 6.2. It consists of a cell for imposing pressure, a semi-permeable diaphragm C, manometer for recording pressure M, and a measuring burette for measuring produced volumes.

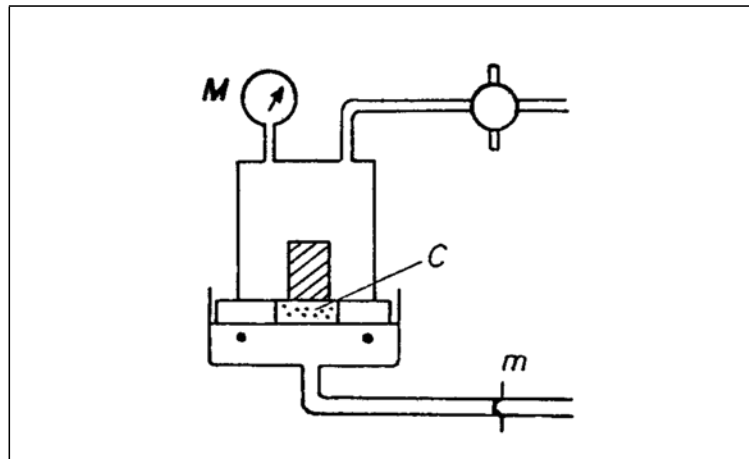

Fig. 6.2: The porous plate method assembly.

During measurement, the pressure is increased in steps and final equilibrium produced volumes of the wetting phase are recorded for each step.

The porous plate method is slow and one full curve may take up to 40 days or more to obtain. However, equipment needed for this method is simple and inexpensive and the

work needed is limited to some volume reading during the process. Several samples may be run in one chamber. Then the samples have to be removed in order to weigh them separately between each pressure increase. Preferably, one and one sample should be run in an assembly of one-sample cells. Then it is not necessary to decrease pressure between each reading.

This method is regarded as the standard method against which all other methods are compared. Routinely only the drainage curve is measured, but with appropriate modifications the imbibition curve may be determined in the same manner. The weakness, as with all the other methods, is the transformation of data to reservoir conditions.

6.2.2 Centrifuge Method

Hassler and Brunner (1945) presented the basic concepts involved in the use of the centrifuge by relating the performance of a small core in a field of high acceleration.

If the cylindrical core of length L is subjected to an acceleration $a_c = -\omega^2 r$ where ω is angular velocity of the centrifuge and r is the distance from the axis of rotation, then from Eq. (5.6) we have

$$\frac{\partial P_c}{\partial r} = \Delta \rho a_c \quad (6.9)$$

Given the boundary conditions show in Fig. 6.3, the differential equation can be solved by simple integration

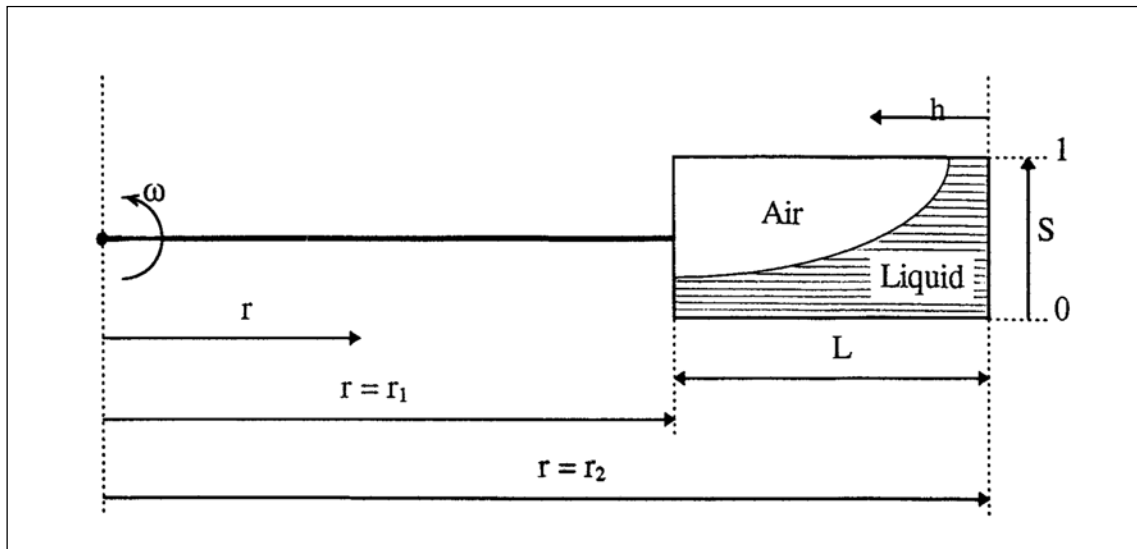

Fig. 6.3: Schematic diagram of a core in a centrifuge and its boundary conditions.

$$P_c = \int_{r_2}^r \Delta \rho a_c dr \quad (6.10)$$

$$P_c(r) = - \int_{r_2}^r \Delta \rho \omega^2 r dr \quad (6.11)$$

The capillary pressure at the outer face of the core is zero, $P_c(r_2) = 0$, so

$$P_c(r) = \frac{1}{2} \Delta \rho \omega^2 (r_2^2 - r^2) \quad (6.12)$$

and for a continuous phase, the capillary pressure at the inner face of the core is

$$P_{cL} = P_c(L) = \frac{1}{2} \Delta \rho \omega^2 (r_2^2 - r_1^2) \quad (6.13)$$

Now, the main purpose is to relate the capillary pressure and saturation S for a given core which gives the saturation in the core at equilibrium with the capillary pressure, $S = S(P_c)$.

The saturation at a distance h above the outer face of the core can not be measured directly. However, the average saturation, which is the ratio of remaining liquid volume after production to pore volume can be written as

$$\bar{S} = \frac{1}{r_2 - r_1} \int_{r_2}^{r_1} S(r) dr \quad (6.14)$$

We will have a relationship of saturation as a function of capillary pressure, $S = S(P_c)$, so Eq. (5.14) can be expressed as follows by changing integration variable

$$P_c(r_2) = 0 \quad \text{and} \quad P_c(r_1) = P_{cL}$$

$$\bar{S} = \frac{1}{r_2 - r_1} \int_{P_{cL}}^0 \frac{S(P_c) dP_c}{-\Delta \rho \omega^2 r} \quad (6.15)$$

An expression for r is obtained from Eq. (6.12)

$$r = r_2 \sqrt{1 - \frac{P_c}{\frac{1}{2} \Delta \rho \omega^2 r_2^2}} \quad (6.16)$$

and we obtain

$$\bar{S} = \frac{1}{(r_2 - r_1) \Delta \rho \omega^2 r_2} \int_0^{P_{cL}} \frac{S(P_c) dP_c}{\sqrt{1 - \frac{P_c}{\frac{1}{2} \Delta \rho \omega^2 r_2^2}}} \quad (6.17)$$

and with mathematical manipulation it becomes

$$\bar{S}P_{cL} = \cos^2(\alpha/2) \int_0^{P_{cL}} \frac{S(P_c) dP_c}{\sqrt{1 - \frac{P_c}{P_{cL}} \sin^2 \alpha}} \quad (6.18)$$

where $\cos \alpha = \frac{r_1}{r_2}$

$$\cos^2(\alpha/2) = \frac{1}{2} (1 + \cos \alpha) = \frac{r_1 + r_2}{2r_2}$$

$$\sin^2 \alpha = 1 - \cos^2 \alpha = 1 - \frac{r_1^2}{r_2^2}$$

Eq. (6.18) cannot be solved so simply for the unknown function S . For small values of α (small core sample), the acceleration gradient along the core can be neglected. Assuming

$$r_1/r_2 \approx 1$$

then

$$\cos^2(\alpha/2) = 1 \quad \text{and} \quad \sin^2 \alpha = 0$$

Eq. (6.18) is then reduced to

$$\bar{S}P_{cL} = \int_0^{P_{cL}} S(P_c) dP_c \quad (6.19)$$

or in differentiation form

$$S_L = \frac{d}{dP_{cL}} (SP) \quad (6.20)$$

In this method the cores is saturated with water (or oil) and rotated at increasing speed. The speed is increased in steps, and average fluid saturations at each speed is calculated from observation of liquid produced. The liquid volume is read with a stroboscope while centrifuge is in motion, and the speed of centrifuge is increased stepwise. When the run is over the cores are removed and weighed.

The value of P_{cL} for each centrifuge speed are then computed from Eq. (6.13), and the average saturation for each core is obtained from the dry and saturated weights and the corresponding pipette reading. From these data a smooth curve is prepared for each core.

Fig. 6.4a shows a typical $\bar{S}P_{cL}$ as a function of P_{cL} and points indicated on the curve are first, second and third speed.

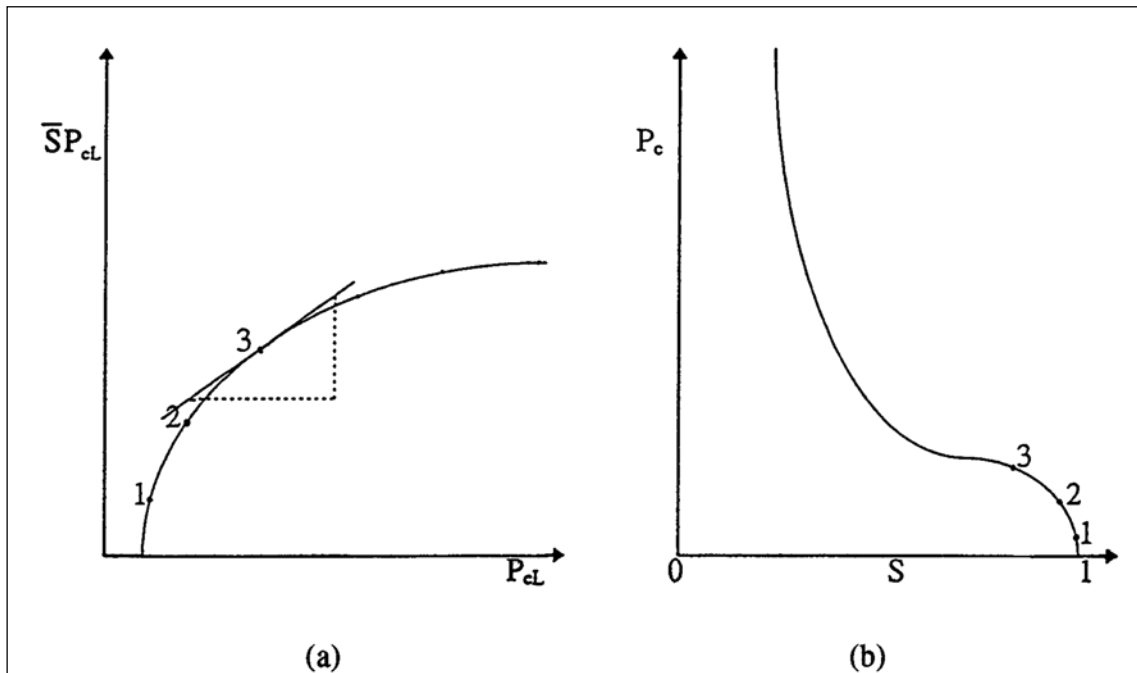

Fig. 6.4: Graphical differentiation of $\bar{S}P_{cL} - P_{cL}$ curve (a) to determine $S - P_c$ curve (b).

The value of saturation that goes with each value of P_{cL} , which now represents the capillary pressure, is obtained from this curve by graphical differentiation according to Eq. (6.20). A typical plot of P_c as a function of S is shown in Fig. 6.4b.

A complete capillary pressure curve by this method may be obtained in a few hours, and several samples are run simultaneously. The method is claimed to be accurate, to reach equilibrium rapidly, give good reproducibility, and is able to produce high pressure differences between phases.

6.2.3 Mercury Injection (Purcell Method)

The test specimen is evacuated and mercury is injected in increments into the core at increasing pressure levels. When the entry pressure is reached, one can easily determine the bulk volume of the core. A mercury injection apparatus is schematically shown in Fig. 6.5. The equipment consists basically of a mercury injection pump, a sample holder cell with a window for observing constant mercury level, manometers, vacuum pump, and a pressurized gas reservoir.

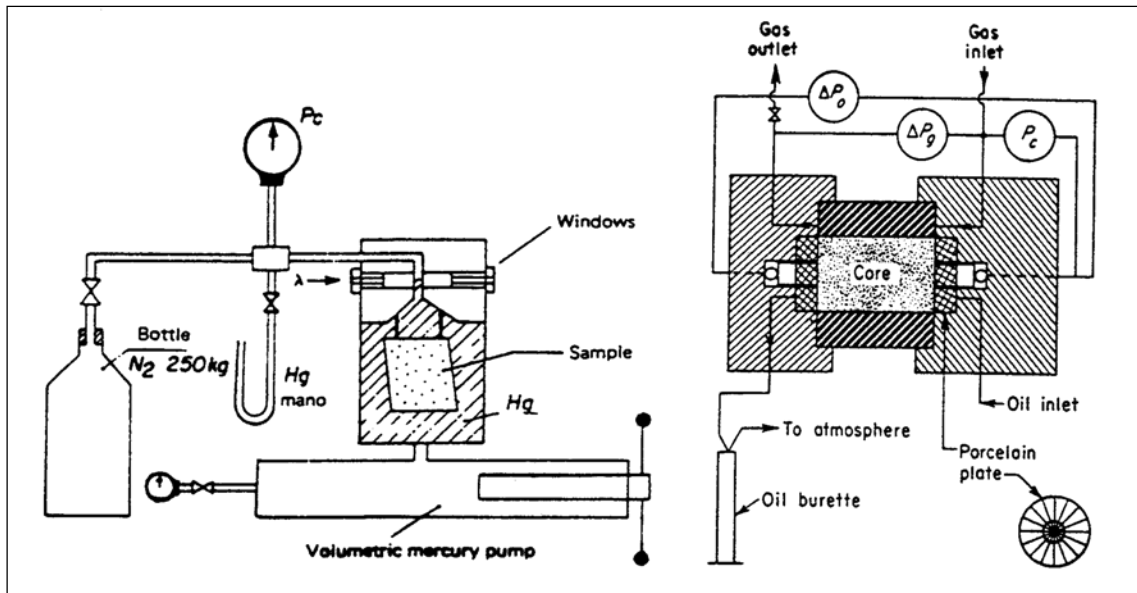

Fig. 6.5: Apparatus for mercury injection method.

Fig. 6.6: Dynamic capillary pressure apparatus.

In this method the mercury injected is calculated as a percentage of pore volume and related to pressure. A practical pressure limit on most equipment is about 15-25 MPa, but equipment for 150 MPa also exists.

Two important advantages are gained with the mercury injection method: (1) the time for determining a complete curve is reduced to less than one hour, and (2) the range of pressure is increased compared with the other methods. However, this method is a destructive method and it is difficult to transform the results to reservoir conditions because of the highly unrealistic fluid system and the uncertainty of wetting of mercury-solid.

Using mercury-air as the fluid-pair, one will not obtain the irreducible saturation as when displacing water with air.

6.2.4 Dynamic Method

The main feature in this method is the way it controls the capillary pressure at both ends of the sample. This is accomplished by placing the tested core between two membranes, or porous plates, which are permeable only to the wetting fluid (Fig. 6.6). This permits maintenance of a uniform saturation throughout the length of the core even at low flow rates.

The membranes permit separate pressure measurements in each of the two phases. The capillary pressure is then equal to the pressure difference between the non-wetting phase and the wetting one at the inflow face. When equilibrium is reached, the sample is removed and its saturation is determined by weighing.

6.2.5 Comparison of Methods

In Table 6.1 advantages and disadvantages of the method are listed. The mercury injection method is primarily used for obtaining pore size distribution data, since it is destructive method. Mercury-air capillary pressure curves have been found to be similar to water-air capillary pressure curves when the mercury-air pressure is divided by a constant. The constant can range from 5.8 to 7.5, depending on the nature of the rock.

The porous plate method is the simplest method conceptually and it must be regarded as the standard method. Small and large samples can be used, and the choice of fluids is not restricted. A serious drawback is the limitation in pressure, since most equipment is limited to about 5 atm.

Table 6.1: Comparison of the methods.

Method	Fluid type	P _c curve type	Max. $\square P$ in lab.	Test time
Porous plate	Oil-water Gas-water Gas-oil	Imbibition Drainage	2-5 atm.	Weeks
Mercury injection	Hg-air	Drainage	100 atm.	Minutes
Centrifuge	Gas-water Oil-water Gas-oil	(Imbibition) Drainage	10 atm.	Days
Dynamic	Gas-water Gas-oil Oil-water	(Imbibition) Drainage	1-10 atm.	Days

The centrifuge can reach capillary pressures higher than the porous plate method, and a large number of samples can be run in a relatively short time.

6.3 Converting Laboratory Data

To use capillary pressure data in reservoir evaluation it is necessary to convert to reservoir conditions. Laboratory data are obtained with a gas-water or an oil-water system, which does not normally have the same physical properties as the reservoir water, oil and gas system.

As shown previously, by means of the capillary tube, the capillary pressure is expressed as

$$P_c = \frac{2\sigma \cos\theta}{r} \quad (6.21)$$

Considering two specific cases wherein the laboratory and reservoir values are determined with gas-water and water-oil respectively. The capillary pressures become

$$(P_c)_L = \frac{2\sigma_{wg} \cos\theta_{wg}}{r} \quad \text{and} \quad (P_c)_R = \frac{2\sigma_{wo} \cos\theta_{wo}}{r} \quad (6.22)$$

where σ_{wg} = interfacial tension between water and gas used in laboratory test
 θ_{wg} = contact angle between water and gas
 σ_{wo} = interfacial tension between reservoir water and oil at reservoir conditions
 θ_{wo} = contact angle between reservoir, water and oil
 r = radius of capillary.

Comparing the equations for laboratory and reservoir capillary pressure and assuming the radius of capillary constant with pressure and temperature, it is found that the reservoir capillary pressure is

$$(P_c)_R = \frac{\sigma_{wo} \cos\theta_{wo}}{\sigma_{wg} \cos\theta_{wg}} (P_c)_L = \frac{(\sigma \cos\theta)_R}{(\sigma \cos\theta)_L} (P_c)_L \quad (6.23)$$

Note that it is difficult to determine the exact value of the contact angle for fluids in a porous matrix, and therefore the contact angles are often neglected. The equation becomes

$$(P_c)_R = \frac{\sigma_R}{\sigma_L} (P_c)_L \quad (6.24)$$

6.4 Experiments

6.4.1 Capillary Pressure Measurement using Porous Plate Method

(Exp. 7) Description:

The porous plate method is the most accurate measurement of capillary pressure in homogeneous and heterogeneous cores. Several plugs can be measured at a time. The limitation is that the capillary discontinuity may distort the results.

Fig. 6.7 shows the capillary pressure apparatus used in our laboratory.

Procedure:

1. Put the saturated core onto the porous plate in the cell.
2. Adjust the pressure regulator and give the cell the pressure difference according to a measuring plan.
3. After 3 days, stop the pressure supply and take off the cores from the cell.
4. Weigh the core and calculate the water saturation corresponding to the capillary pressure.
5. Repeat 1-4 each 3 days until no appreciable water is produced.

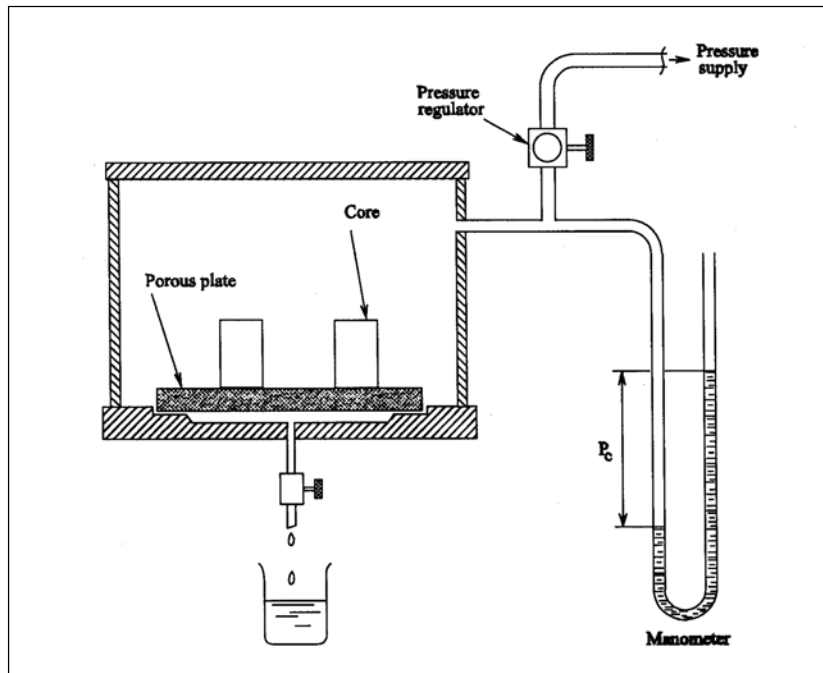

Fig.6.7: The capillary pressure apparatus.

Calculations and report:

1. Calculate and fill the data form.
2. Plot capillary pressure curve (S_w-P_c) and pore size histogram (distribution).

Core No. D: cm, L: cm, W_{dry} : g, W_{sat} : g, $\phi =$

Date	No. (i)	$P_{c(i)}$, H_{water} (cm)	$W_{wet(i)}$ (g)	$S_{w(i)}$ (fraction)	$r_{(i)}$ (μm)	$\frac{\Delta W_{(i)}}{W_{water}}$
	0					
	1					
	2					
	3					
	4					
	5					

where

$P_{c(i)}$ = capillary pressure of i^{th} measurement, cm of water, reading of U-manometer

W_{wet} = core weight of i^{th} measurement, g

$S_{w(i)} = (W_{wet(i)} - W_{dry}) / W_{water}$, i^{th} water saturation of $P_{c(i)}$
 $W_{water} = W_{sat} - W_{dry}$, g

$r_{(i)} = 2\sigma_{g-w} / P_{c(i)}$, radius corresponding to $P_{c(i)}$

$\sigma_{g-w} = 70.0$ dynes/cm, interfacial tension of gas-water

$P_{c(i)} = 981 \cdot H_{water}$, dynes/cm²

$\Delta W_{(i)} / W_{water} = (W_{wet(i-1)} - W_{wet(i)}) / W_{water}$, fraction of the capillaries of $r_{(i)}$ in total pore volume.

6.4.2 Capillary Pressure Measurement using Centrifuge Method

(Experiment 8) Description:

The objective of the experiment is to measure capillary pressure in a core sample and plot the capillary pressure versus water saturation curve.

Procedure:

6. Measure the pore volume and bulk volume of a cleaned and dried core sample. Weigh the dry core, W_{dry} .
7. Saturate the core sample with the brine/water with density ρ_w . Weigh the saturated core, W_{sat} .
8. Place the core sample in a centrifuge core holder and start the centrifuge with rotation rate of 500 RPM.
9. Monitor the displaced fluid volume in the measuring tube while the centrifuge is in motion, by adjusting the strobe light frequency to the rotational speed of the centrifuge.
10. Record the collected fluid volume V_{coll} in the graduated tube when the volume of collected fluid shows no further changes.
11. Repeat the procedure described in the steps 4 and 5 at higher rotational speed.

Calculations and report:

1. Calculate pore volume of the core sample: $V_p = \frac{W_{sat} - W_{dry}}{\rho_w}$.

2. Convert RPM to rad/s: $\omega = \frac{2\pi (RPM)}{60}$.

3. Calculate capillary pressure at each step: $P_{cL} = \frac{1}{2} \rho_w \omega^2 (r_2^2 - r_1^2)$.

where

$$r_2 = 0.145 \text{ m}$$

$$r_1 = r_2 - L$$

L = length of the core sample

4. Calculate average water saturation \bar{S}_w in the core sample based on the volume of the water collected at corresponding capillary pressure: $\bar{S}_w = 1 - \frac{V_{coll}}{V_p}$.

5. Plot \bar{S}_w versus P_{cL} .

6. Draw tangents to the plot of the curve at each point and calculate the slope of each tangent. These slopes are the water saturation values S_w at the corresponding capillary pressure.

7. Plot the capillary pressures as a function of the water saturations.

Core No.: D : cm, L : cm.

RPM	ω (rad/s)	P_{cL} (bar)	V_{coll} (cm ³)	\bar{S}_w	$\bar{S}P_{cL}$ (bar)	S_w from plot
500						
750						
1000						
1500						
2000						
2500						

7. RESISTIVITY

7.1 Definitions

Porous rocks are comprised of solid grains and void space. The solids, with the exception of certain clay minerals, are nonconductors. The electrical properties of a rock depend on the geometry of the voids and the fluid with which those voids are filled. The fluids of interest in petroleum reservoirs are oil, gas, and water. Oil and gas are nonconductors. Water is a conductor when it contains dissolved salts, such as NaCl, MgCl₂, KCl normally found in formation reservoir water. Current is conducted in water by movement of ions and can therefore be termed *electrolytic conduction*.

The *resistivity* of a porous material is defined by

$$R = \frac{rA}{L} \quad (7.1)$$

where r = resistance, Ω

A = cross-sectional area, m^2

L = length, m

and resistivity is expressed in Ohm-meter ($\Omega.m$). However, for a complex material like rock containing water and oil, the resistivity of the rock depends on

- salinity of water
- temperature
- porosity
- pore geometry
- formation stress
- composition of rock.

The resistivity of an electric current in porous rock is due primarily to the movement of dissolved ions in the brine that fills the pore of the rock. The resistivity varies with temperature due to the increased activity of the ions in solution as temperature increases.

Due to the conductivity properties of reservoir formation water, the electrical well-log technique is an important tool in the determination of water saturation versus depth and thereby a reliable resource for in situ hydrocarbon evaluation.

The theory of the electrical resistivity log technique generally applied in petroleum engineering was developed by Archie in 1942, the so called Archie's equation. This empirical equation was derived for clean water-wet sandstones over a reasonable range of water saturation and porosities. In practice, Archie's equation should be modified according to the rock properties: clay contents, wettability, pore distribution, etc. The following is a brief presentation of the main electrical properties of reservoir rocks and related parameters.

Formation Factor: The most fundamental concept considering electrical properties of rocks is the formation factor F , as defined by Archie:

$$F = \frac{R_o}{R_w} \quad (7.2)$$

where

R_o = the resistivity of the rock when saturated 100% with water, $\Omega.m$

R_w = the water resistivity, $\Omega.m$.

The formation factor shows a relationship between water saturated rock conductivity and bulk water conductivity. Obviously, the factor depends on the pore structure of the rock.

Resistivity Index: The second fundamental notion of electrical properties of porous rocks containing both water and hydrocarbons is the resistivity index I .

$$I = \frac{R_t}{R_o} \quad (7.3)$$

where

R_t = the resistivity of the rock when saturated partially with water, $\Omega.m$

R_o = the resistivity of the same rock when saturated with 100% water, $\Omega.m$.

Tortuosity: Wyllie developed the relation between the formation factor and other properties of rocks, like porosity ϕ and tortuosity τ . Tortuosity can be defined as $(L_a/L)^2$, where L is the length of the core and L_a represents the effective path length through the pores. Based on simple pore models the following relationship can be derived:

$$F = \frac{\tau}{\phi} \quad (7.4)$$

where

F = formation factor

τ = tortuosity of the rock

ϕ = porosity of the rock.

Cementation factor: Archie suggested a slightly different relation between the formation factor and porosity by introducing the cementation factor:

$$F = \phi^{-m} \quad (7.5)$$

where

ϕ = porosity of the rock

m = Archie's cementation factor.

Archie reported that the cementation factor probably ranged from 1.8 to 2.0 for consolidated sandstones and for clean unconsolidated sands was about 1.3.

Saturation Exponent: The famous Archie's equation gives the relationship of resistivity index with water saturation of rocks

$$I = \frac{R_t}{R_o} = S_w^{-n} \quad (7.6)$$

where

S_w = water saturation

n = saturation exponent, ranging from 1.4 to 2.2 ($n = 2.0$ if no data are given).

In this equation, R_t and R_o can be obtained from well logging data, saturation exponent n is experimentally determined in laboratory. Therefore, the in situ water saturation can be calculated with Archie's equation. Based on the material balance equation for the formation, $S_w + S_o + S_g = 1.0$, the hydrocarbon reserve in place may be calculated.

7.2 Effect of Conductive Solids

The clay minerals present in a natural rock act as a separate conductor and are sometimes referred to as "conductive solids". Actually, the water in the clay and the ions in the water act as the conducting materials. Fig. 7.1 shows variation of formation factor versus water resistivity for clean and clayey sands. The effect of the clay on the resistivity of the rock is dependent upon the amount, type and manner of distribution of the clay in the rock.

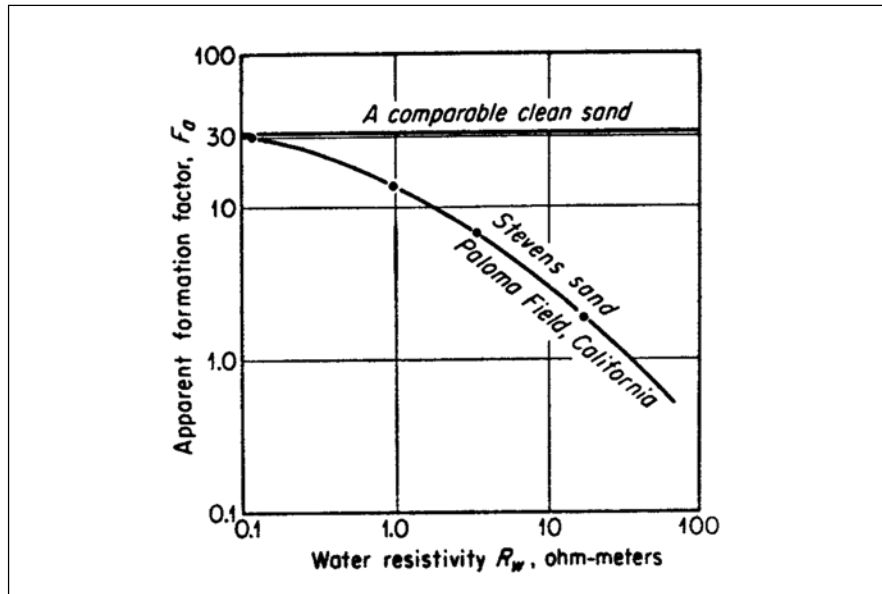

Fig. 7.1: **Apparent formation factor versus water resistivity** for clayey and clean sands.

The formation factor for clay-free sand is constant. The formation factor for clayey sand increases with decreasing water resistivity and approaches a constant value at a water resistivity of about 0.1 Ω .m. The apparent formation factor F_a was calculated from the definition of the formation factor and observed values of R_{oa} and R_w ($F_a = R_{oa}/R_w$). Wyllie proposed that the observed effect of clay minerals was similar to having two electrical circuits in parallel: the conducting clay minerals and the water-filled pores. Thus

$$\frac{1}{R_{oa}} = \frac{1}{R_c} + \frac{1}{FR_w} \quad (7.7)$$

where R_{oa} is the resistivity of a shaly sand when 100% saturated with water of resistivity R_w . R_c is the resistivity due to the clay minerals. FR_w is the resistivity due to the distributed water, and F is the true formation factor of the rock (the constant value when the rock contains low-resistivity water).

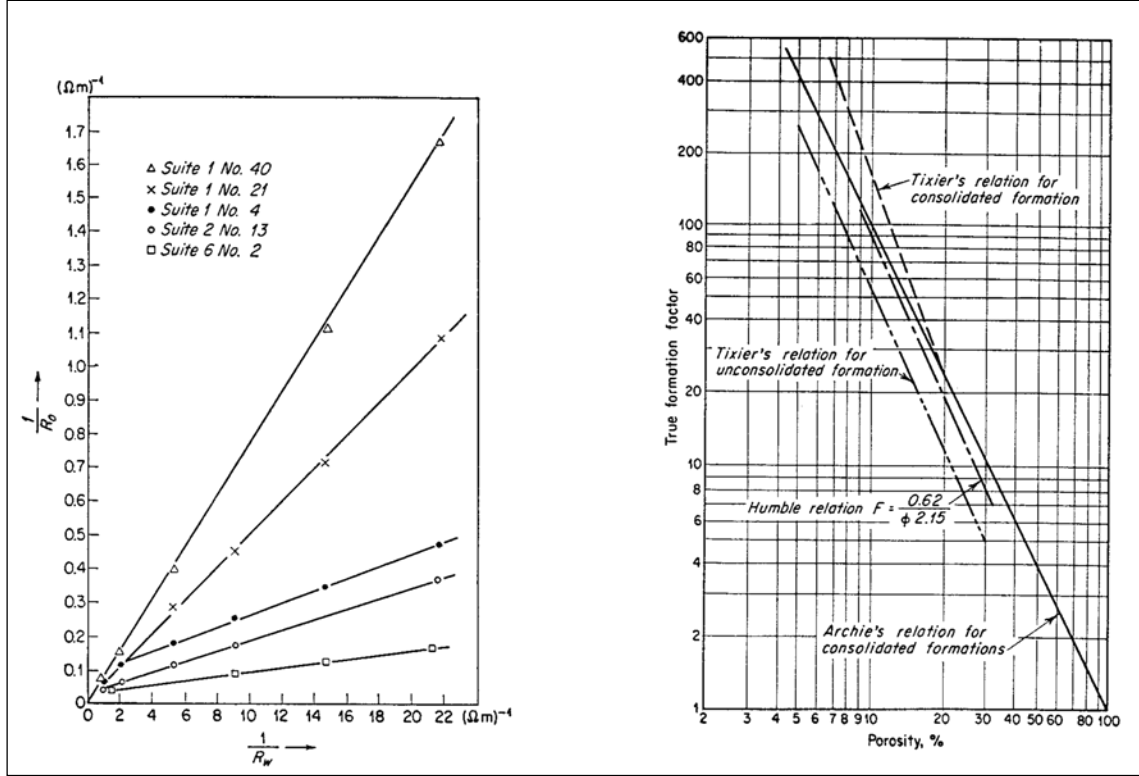

Fig. 7.2: Water-saturated rock conductivity as a function of water conductivity.

Fig.7.3: Formation factor as a function of porosity.

The data presented at the Fig. 7.2 represent graphically the confirmation of the relationship expressed in Eq. (7.7). The plots are linear and are of the general form

$$\frac{1}{R_{oa}} = C \frac{1}{R_w} + b \quad (6.8)$$

where C is the slope of the line and b is the intercept. Comparing Eq. (7.7) with Eq. (7.8), it may be noted that $C = 1/F$ and $b = 1/R_c$. The line in which $b = 0$ indicates a clean sand, then

$$\frac{1}{R_{oa}} = C \frac{1}{R_w} = \frac{1}{FR_w} \quad \text{or} \quad R_o = FR_w \quad (7.9)$$

Eq. (7.7) can be rearranged to express the apparent formation factor in term of R_c and FR_w

$$R_{oa} = \frac{R_c R_w}{R_w + \frac{R_c}{F}} \quad \text{and} \quad F_a = \frac{R_c}{R_w + \frac{R_c}{F}} \quad (7.10)$$

As $R_w \rightarrow 0$, $\lim_{R_w \rightarrow 0} F_a = \frac{R_c}{\frac{R_c}{F}} = F$. Therefore F_a approaches F as a limit as R_w become small.

This was observed in Fig. 7.1.

7.3 Effect of Overburden Pressure on Resistivity

Confinement or overburden pressure may cause a significant increase in resistivity. This usually occurs in rocks that are not well cemented and in lower porosity rocks. Archie, as mentioned before, reported results of correlating laboratory measurements of formation factor with porosity in the form

$$F = \phi^{-m} \quad (7.11)$$

Wyllie investigated the influence of particle size and cementation factor on the formation factor of a variety of materials. He concluded that the cemented aggregates exhibit a greater change in formation factor with a change in porosity than the unconsolidated aggregates. Then, the general form of the relation between formation factor and porosity should be

$$F = a\phi^{-m} \quad (7.12)$$

where m is a constant depending on cementation and a a constant controlled by the porosity of the unconsolidated matrix prior to cementation. A comparison of some suggested relationships between porosity and formation factor is shown in Fig. 7.3.

7.4 Resistivity of Partially Water-Saturated Rocks

When oil and gas are present within a porous rock together with a certain amount of formation water, its resistivity is larger than R_o since there is less available volume for the flow of electric current. This volume is a function of the water saturation S_w . Eq. (7.6) indicates that the resistivity index is a function of water saturation and the path depth. From the theoretical development, the following generalization can be drawn:

$$I = C'S_w^{-n} \quad (7.13)$$

where $I = R/R_o$ is the resistivity index, C' is some function of tortuosity and n is the saturation exponent. In Archie's equation n is 2.0 and in Williams relation 2.7 (Fig. 7.4). All the equations fitted to the experimental data have assumed that both C' and n of Eq. (7.13) were constants and furthermore that $C' = I$.

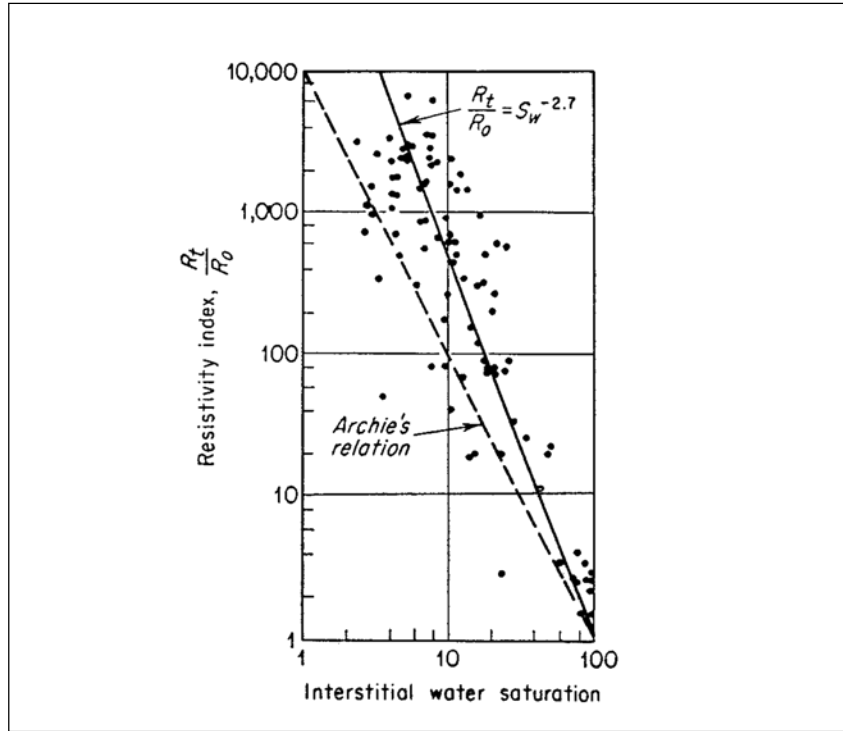

Fig. 7.4: Resistivity index versus water saturation.

The generally accepted formation which relates water saturations and true resistivity R_t is that of Archie, which may be written in the following different form:

$$S_w = \sqrt[n]{\frac{R_o}{R_t}} = \sqrt[n]{\frac{FR_w}{R_t}} = \sqrt[n]{\frac{R_w}{R_t} \frac{a}{\phi^m}} \quad (7.14)$$

where a is unique property of the rock and n is the saturation exponent, which in most cases is assumed to be 2.0.

7.5 Experiments

7.5.1 Resistivity Measurements of Fluid-Saturated Rocks (Experiment 9)

Description:

The objective of this experiment is to measure the main electrical properties of porous rock like water resistivity, formation factor, tortuosity, cementation factor, resistivity index and saturation exponent.

Procedure:

Resistance measurements in our laboratory are a *ratio of voltage decrease method*, that is the ratio of voltage decrease between a reference resistor and a sample (to be measured) in series (Fig. 7.5). Then, the resistance of the sample is calculated and the resistivity of the sample can be developed when the size of the sample is known.

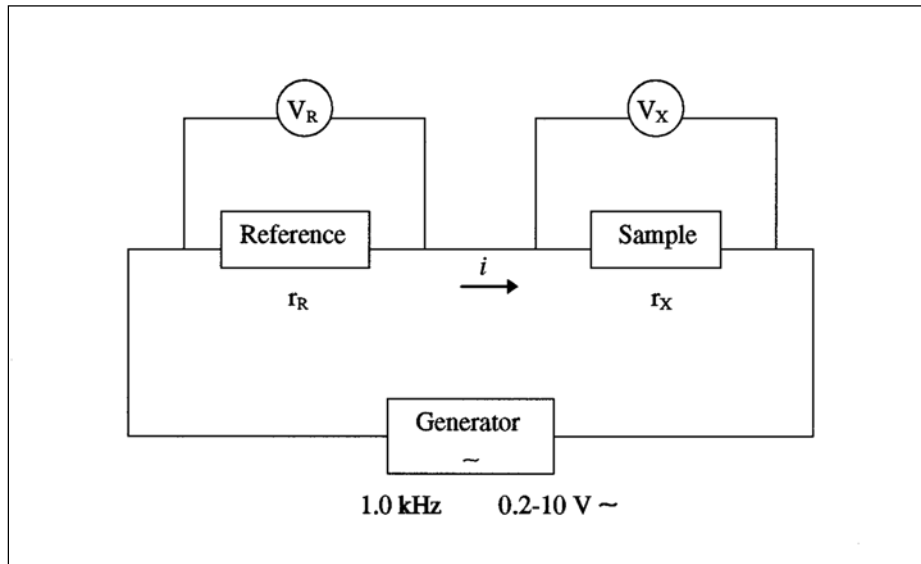

Fig. 7.5: The electrical circuit of resistance measurements.

Calculations and report:

1. Calculate water resistivity, R_w

Equation:

$$R_w = \frac{r_x A}{L} = \frac{r_x \pi D^2}{4L}$$

Reference resistance (r_R): Ω , V_X/V_R :

Water	Cell diameter D (m)	Cell length L (m)	Cell resistance, r_x (Ω)	Water resistivity R_w ($\Omega.m$)
36 g NaCl/l				

2. Calculate formation factor, F , tortuosity, τ , and cementation factor, m

Reference resistance (r_R): Ω , V_X/V_R :

Core No.	Core D (m)	Core L (m)	r_x (Ω)	R_o ($\Omega.m$)	Porosity ϕ	Cementation factor, m	Formation Factor, F	Tortuosity, τ

R_w is equal to the value of R_w in (1).

3. Calculate resistivity index, I , saturation exponent, n

Reference resistance (r_R): Ω , V_X/V_R :

Core No.	Core D (m)	Core L (m)	r_x (Ω)	R_t ($\Omega.m$)	R_o ($\Omega.m$)	S_w	Resistivity Index, I	Saturation exponent, n

R_o is equal to the value of R_o in (2).

References

- Adamson A.W.: "Physical Chemistry of Surfaces", *John Wiley & Sons*, 1982.
- Amyx J.W., Bass Jr. D.M. and Whiting R.L.: "Petroleum Reservoir Engineering", *McGraw-Hill*, 1960.
- Archie G.E.: "The Electrical Resistivity Log as an Aid in Determining Some Reservoir Characteristics", *AIME*, 1942, p. 54.
- Bear J.C.: "Dynamic of Fluids in Porous Media", *American Elsevier*, 1972.
- Berg J.C.: "Wettability", *Marcel Dekker Inc.*, 1993.
- Bourgoyne Jr. A.T., Millheim K.K., Chenevert M.E. and Young Jr. F.S.: "Applied Drilling Engineering", *SPE*, 1986.
- Buckley, S.E.: "Mechanisms of Fluid Displacement in Sands", *AIME*, 1942, vol. 146, 107.
- Collins R.E.: "Flow of Fluid through Porous Materials", *Reinhold Pub. Co.*, 1961.
- Cosse R.: "Basics of Reservoir Engineering", *Editions Technip*, Paris, 1993.
- Craig F.: "The Reservoir Engineering Aspects of Waterflooding", Monograph Volume 3, *AIME*, 1971.
- Dake L.P.: "Fundamentals of Reservoir Engineering", *Elsevier*, 1978.
- Golan M. and Whitson C.H.: "Well Performance", *Prentice Hall*, 1991.
- Hassler G.L. and Brunner E.: "Measurement of Capillary Pressure in Small Core Samples", *AIME*, 1945 Vol. 160, 114.
- Hjelmeland O. and Torsæter O.: "Coring and Core Analysis", *SINTEF Report*, Trondheim, 1984.
- Johnson E.F.: "Calculation of Relative Permeability from Displacement Experiments", *AIME*, 1959, vol. 216, 370.
- Kleppe J., Berg E.W., Buller A.T., Hjelmeland O. and Torsæter O.: "North Sea Oil and Gas Reservoirs", *Graham & Trolman Lim.*, 1985.
- Koederitz L.F., Harvey A.H. and Honarpour M.: "Introduction to Petroleum Reservoir Analysis; Laboratory Workbook", *Gulf Pub. Co.*, 1989.
- Mayer-Gürr: "Petroleum Engineering", *Ferninand Enke Verlag*, Stuttgart, 1976.

Monicard R.F.: “Properties of Reservoir Rocks; Core Analysis”, *Edition Technip*, Paris, 1980.

Morrow, N.R.: “Wettability and Its Effect on Oil Recovery”. *JPT*, Dec. 1990, p1476-1484”

Pirson S.J.: “Oil Reservoir Engineering”, *McGraw-Hill*, 1958.

Shaw D.J.: “Introduction to Colloid and Surface Chemistry”, *Butter Worth & Co.*, 1980.

Skjæveland S.M. and Kleppe J.: “Recent Advances in Improved Oil Recovery Methods for North Sea Sandstone Reservoirs”, Norwegian Petroleum Directorate, Stavanger, 1992.

Torsæter O.: “A comparative Study of Wettability Test Methods Based on Experimental Results from North Sea Reservoir rocks”. Paper *SPE* 18281, Houston, Tx., Oct. 1988.

Welge, H.J.: “Simplified Method for Computing Oil Recovery by Gas or Water Drive”, *AIME*, 1952, Vol. 195, 91.

Wyllie M.R.J. and Spangler M.B.: “Application of Electrical Resistivity Measurements to Problem of Fluid Flow in Porous Media”, *Bull. AAPG*, Feb. 1952, p. 359.